

KNIPEX Quality – Made in Germany



# KNIPEX Automotive Range

Further products on  
[www.knipex.com](http://www.knipex.com)

# Pliers for the automotive trade

An everyday challenge for motor mechanics is that ever more components are installed in an ever smaller space in the engines of modern vehicles. In order to be able to work quickly and reliably despite this lack of space, it is important to have the right tool to hand. Pliers from KNIPEX are impressive because even with the small models, they require little manual force for a highly effective result. The huge breadth of the range, comprising over 80 different models of circlip pliers alone, is a big advantage for the motor trade.

The KNIPEX range has indispensable standard and special pliers for all work in the vehicle. KNIPEX offers various models of special pliers to open and close the numerous hose connections in the engine, on CV boots, rubber gaiters, cooling hoses or bypass pipes.



































Spring hose clamp pliers grip standard clamps, space-saving clamps, wire clamps and spring band clamps with a nominal size of up to 70 mm as are frequently used on radiator hoses, firmly and securely. As a result of their compact dimensions and the jaw inserts that can be rotated under load, clamps can be easily accessed even in confined spaces. Click clamps, e.g. on bypass pipes, are sealed quickly and pressure tight using the hose clamp pliers. The slim head of the pliers ensures good accessibility, rotating jaw inserts enables them to be applied flexibly from diverse angles.

KNIPEX has developed the ear clamp pliers for the professional crimping of ear clamps that are often to be found on CV boots and rubber gaiters; their jaws have been designed specifically for the reliable assembly of 1-ear and 2-ear clamps.

Discover your KNIPEX pliers for the motor trade in this brochure!



## SYMBOLS

	flat jaws		with lead catcher		electrostatic discharging, dissipative		soft wire
	half-round jaws		angle		electronics		medium hard wire
	round jaws		weight		VDE-tested, also in compliance with GPSG		hard wire
	flat and pointed jaws		length		insulated according to IEC 60900, usable up to 1000 V AC / 1500 V DC		piano wire
	box-joint		centre cutter		conforms to a European directive		Cu- + Al-multi-conductor cable, solid and multi-stranded
	bolted joint		cutting edges with bevel		mechanically tested in accordance with the equipment and product safety act		wire rope
	smooth gripping surfaces		cutting edges with small bevel		WEEE marking (Waste Electrical and Electronic equipment Directive)		iron
	knurled gripping surfaces		cutting edges with very small bevel		ribbon cable		steel wire armoured cable (SWA)
	cross-hatched, knurled gripping surfaces		cutting edges without bevel				
	with opening spring		for flush cut of soft materials				

 Further details and explanations can be found on the final pages.



# New products 2020



**KNIPEX Pliers Wrench | p. 6**

Less weight, more performance

86 01 300

**KNIPEX Cobra® XS | p. 4**

Now in a 100 mm model



87 00 100



**KNIPEX StepCut | p. 8**

Innovative step cut

95 11 160



**KNIPEX PreciStrip16 | p. 10**

Automatic Insulation Stripper

12 52 195



**KNIPEX CoBolt® S | p. 9**

160 mm length,  
now with recess  
for round materials

71 31 160



# KNIPEX Cobra® XS

Only 100 mm in length:  
anything but a toy!



The slim head provides firm grip even in tight spaces



Gripping capacity  
**Ø 28 mm**



Work with only one hand: open, slide in, it fits!





**Grips like a big tool: The smallest water pump pliers in the world with full functional capability**

Optimum access in the narrowest spaces: an especially compact design with a very slim head

Single-handed fine adjustment by sliding for optimal fitting to various workpiece sizes

Long-lasting secure grip ensured by high wear resistance

- > Gripping capacity Ø 28 mm (1"), width across flats up to 24 mm – at only 100 mm length
- > Box joint: high quality and durability provided by dual guide
- > Gripping surfaces with specially hardened teeth, hardness approx. 60 HRC
- > Self-locking on pipes and nuts: no slipping on the workpiece and low handforce required
- > Pinch guard prevents operators' fingers being pinched
- > Fine adjustment with 11 adjustment positions
- > DIN ISO 8976

**NEW**  
PAT. PEND.



87 00 100

**The KNIPEX Cobra® Family has grown**

In every size: perfect tightening, gripping, holding, pressing and bending with the ingenious self-locking effect



87 00 100

87 01 125

87 01 150

87 01 180

87 01 250

87 01 300

87 01 400

87 01 560

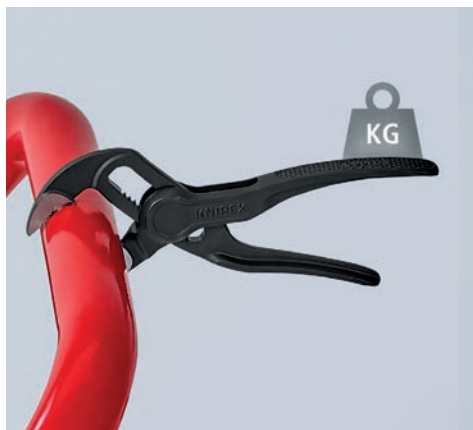

Self-locking and durable – all part of genuine KNIPEX water pump pliers



The KNIPEX Cobra® XS grips nuts up to 24 mm and other workpieces as large as Ø 28 mm



Naked truth: The grips are not coated to keep them as slim as possible. To ensure good grip, they are textured on the outside

Article No.	EAN	↔		Pliers	Head	Handles	Adjustment positions	⊘	⬡	⚖
	4003773-	mm						Ø Inch	mm	g
87 00 100	085836	100		grey atramentized	polished	embossed, rough surface	11	1	24	62
87 00 100 BK	085843	100				embossed, rough surface	11	1	24	87
87 01 125	069935	125				with non-slip plastic coating	13	1	27	85
87 01 150	060116	150					11	1 1/4	30	145
87 01 180	022015	180					18	1 1/2	36	170
87 01 250	022022	250					25	2	46	335
87 01 300	034087	300					30	2 3/4	60	530
87 01 400	005636	400					27	3 1/2	95	1214
87 01 560	044321	560				20	4 1/2	120	2750	

**Now optimised: Less weight, more performance, with a larger opening width and a practical laser-cut adjustment scale**

**Higher capacity: Continuous gripping in all wrench sizes up to 68 mm (maximum 2 1/2") with use of two additional adjustment positions**

**Noticeably less weight, 80 grams lighter with the same stability**

**Practical adjustment scale: A laser-cut (metric and imperial) enables pre-setting to the width across flats**

- > Replaces a whole set of spanners – metric and imperial
- > Smooth jaws for damage-free installation of plated fittings - working directly on chrome!
- > Reliable catching of the hinge bolt: no unintentional shifting
- > Lever transmission greater than 10:1 for strong gripping power
- > Chrome vanadium electric steel, forged, oil-hardened

**For especially sensitive surfaces:**  
plastic protective jaw covers are available as accessories for all optimised pliers wrenches

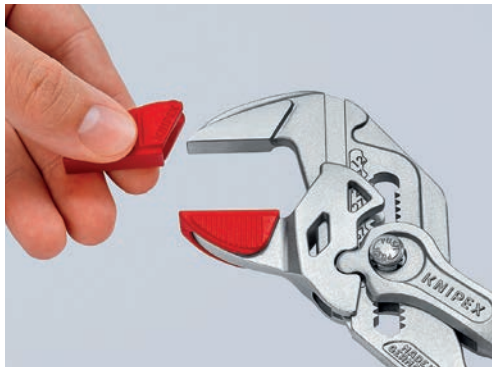

**Even better:  
the optimised pliers wrench**

The new versions of the tried-and-tested pliers wrench. You will recognise them **1** by the offset jaws, **2** the laser-cut scale for pre-setting of width across flats



**86 01 180 and  
86 03 180**

**86 01 250 and  
86 03 250**

**86 01 300 and  
86 03 300**

Article No.	EAN 4003773-	↔ mm		Pliers	Head	Handles	Adjustment positions	⬡ Inch	⬡ mm	⚖ g
86 03 125	077497	125	□	chrome plated		plastic coated	11	7/8	23	105
86 03 125 SB	077688	125	□	chrome plated		plastic coated	11	7/8	23	105
86 03 150	069676	150	□	chrome plated		plastic coated	14	1	27	193
86 03 150 SB	070009	150	□	chrome plated		plastic coated	14	1	27	193
86 01 180	<b>N</b> 084273	180	□	grey atramentized	polished	with non-slip plastic coating	15	1 1/2	40	230
86 01 180 SB	<b>N</b> 084303	180	□	grey atramentized	polished	with non-slip plastic coating	15	1 1/2	40	230
86 01 250	082385	250	□	grey atramentized	polished	with non-slip plastic coating	19	2	52	457
86 01 250 SB	082637	250	□	grey atramentized	polished	with non-slip plastic coating	19	2	52	457
86 01 300	<b>N</b> 084662	300	□	grey atramentized	polished	with non-slip plastic coating	24	2 1/2	68	645
86 01 300 SB	<b>N</b> 084679	300	□	grey atramentized	polished	with non-slip plastic coating	24	2 1/2	68	645
86 02 180	<b>N</b> 084280	180	□	grey atramentized	polished	with multi-component grips	15	1 1/2	40	240
86 02 180 SB	<b>N</b> 084310	180	□	grey atramentized	polished	with multi-component grips	15	1 1/2	40	240
86 02 250	082392	250	□	grey atramentized	polished	with multi-component grips	19	2	52	468
86 02 250 SB	082644	250	□	grey atramentized	polished	with multi-component grips	19	2	52	468
86 03 180	<b>U</b> 035466	180	□	chrome plated		plastic coated	15	1 1/2	40	230
86 03 180 SB	<b>U</b> 028819	180	□	chrome plated		plastic coated	15	1 1/2	40	230
86 03 250	033837	250	□	chrome plated		plastic coated	19	2	52	462
86 03 250 SB	022091	250	□	chrome plated		plastic coated	19	2	52	462
86 03 300	<b>U</b> 041429	300	□	chrome plated		plastic coated	24	2 1/2	68	645
86 03 300 SB	<b>U</b> 040927	300	□	plastic coated		plastic coated	24	2 1/2	68	645
86 03 400	077312	400	□	chrome plated		plastic coated	25	3 3/8	85	400
86 05 180	<b>U</b> 047162	180	□	chrome plated		with multi-component grips	15	1 1/2	40	250
86 05 180 SB	<b>U</b> 052180	180	□	chrome plated		with multi-component grips	15	1 1/2	40	250
86 05 250	047841	250	□	chrome plated		with multi-component grips	19	2	52	485
86 05 250 SB	052029	250	□	chrome plated		with multi-component grips	19	2	52	485
86 06 250	082408	250	□	chrome plated		insulated with multi-component grips, VDE-tested	19	2	52	515
86 06 250 SB	082651	250	□	chrome plated		insulated with multi-component grips, VDE-tested	19	2	52	515
86 09 180 V01	<b>N</b> 085805	3 pairs of plastic jaws for all 86 XX 180 mm models (models from 2019)								9
86 09 250 V01	084143	3 pairs of plastic jaws for all 86 XX 250 mm models (models from 2018)								18
86 09 300 V01	<b>N</b> 085812	3 pairs of plastic jaws for all 86 XX 300 mm models (models from 2020)								24



# All advantages of the optimised pliers wrenches at a glance:

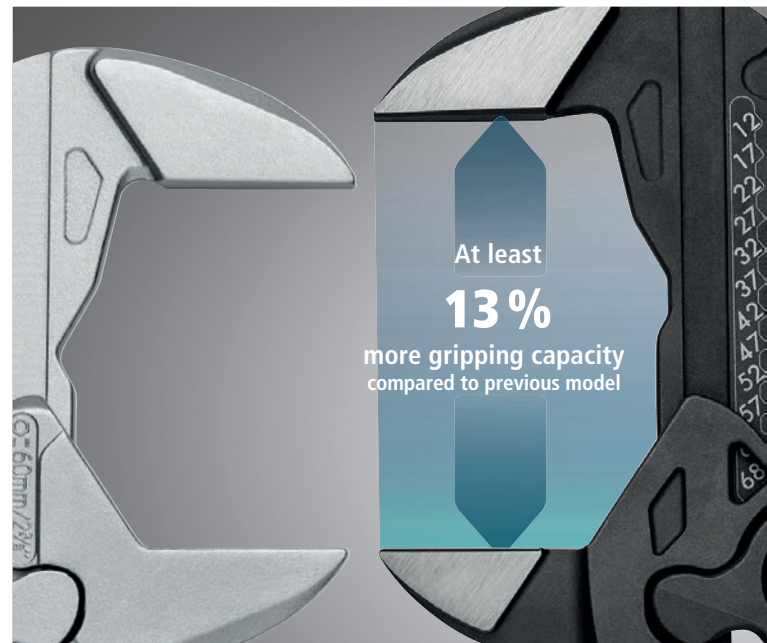
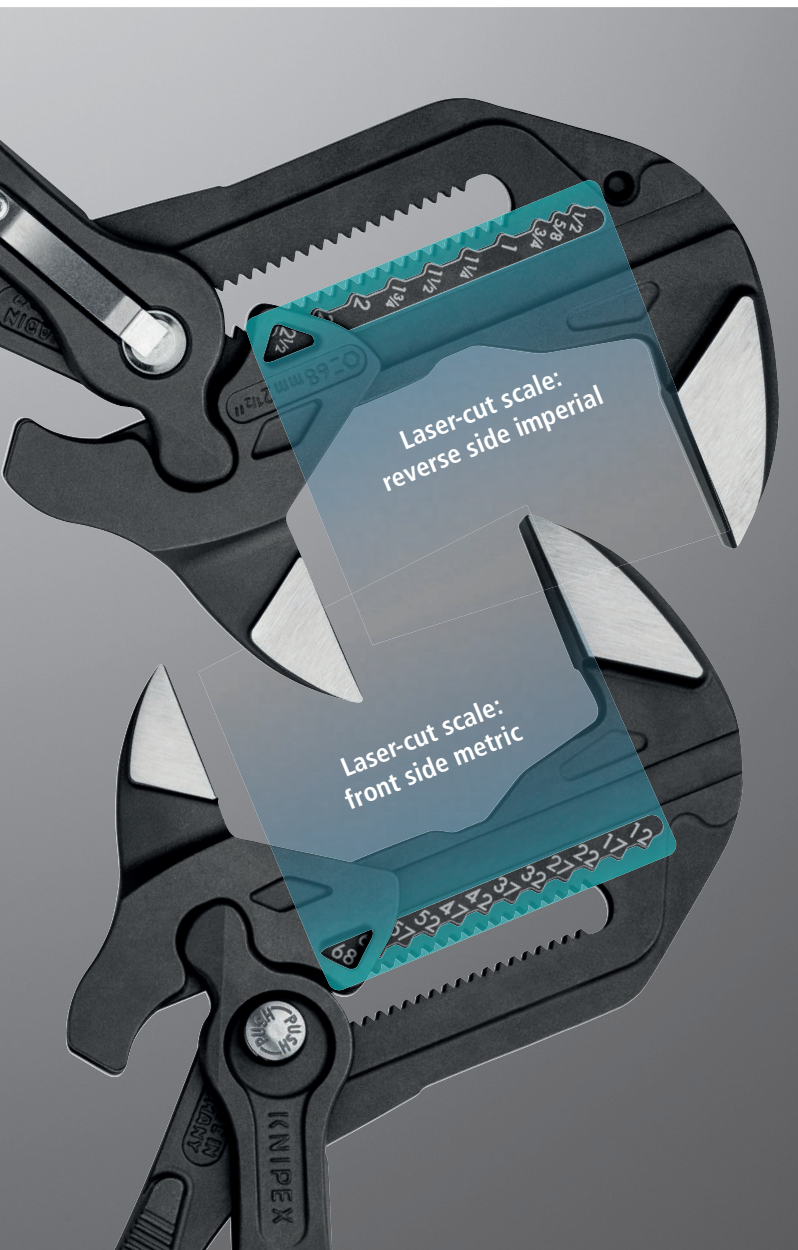

**Cable cutting made easy: innovative step cutting separates wires one by one to save energy**

Small, light, strong: comfortable cutting without crushing and just 160 mm in size

Noticeably less effort: the gradations cut wires one after the other; cutting is up to 40 % easier than with standard cable shears of the same length!

Ergonomic handle design: optimal cutting feel even for larger cable diameters

- > Cuts multi-core stranded copper and aluminium cables up to Ø 15 mm (50 mm<sup>2</sup>)
- > Cuts solid copper and aluminium cables up to 5 x 4 mm<sup>2</sup>
- > Cuts without crushing
- > Bolted joint: precise, effortless, durable
- > Pinch guard fitted for safe work
- > Not suitable for steel wire and hard drawn copper conductors
- > Cutting edges additionally induction-hardened, cutting edge hardness at least 56 HRC
- > High-grade special tool steel, forged, oil-hardened

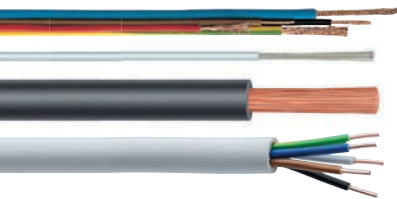

**NEW**  
PAT. PEND.



95 11 160



95 12 160

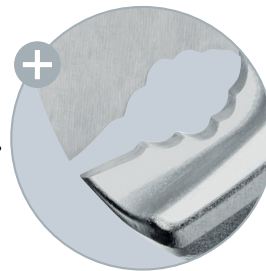

The gradations cut wires one after the other, without crushing



95 16 160



Cuts solid Cu- and Al-cable up to 5 x 4 mm<sup>2</sup>



Bolted joint: precise, smooth-running, durable; with pinch guard



Article No.	EAN 4003773-	↔ mm	Tool	Handles	Cutting capacities			
					⊘ mm	mm <sup>2</sup>	AWG	g
95 11 160	085904	160	burnished	plastic coated	15.0	50	1 / 0	180
95 11 160 SB	085911	160	burnished	plastic coated	15.0	50	1 / 0	205
95 12 160	085928	160	burnished	with multi-component grips	15.0	50	1 / 0	220
95 12 160 SB	085935	160	burnished	with multi-component grips	15.0	50	1 / 0	245
95 16 160	085966	160	chrome plated	insulated with multi-component grips, VDE-tested	15.0	50	1 / 0	225
95 16 160 SB	085898	160	chrome plated	insulated with multi-component grips, VDE-tested	15.0	50	1 / 0	250



**Tiny titan with 25-fold leveraging of hand strength –  
just right for round material**

Heavy-duty cutting edge with recess slices through the hardest round materials in only one cutting action

Extremely high cutting performance in a convenient length of 160 mm

Small, slim head for excellent accessibility

- > Compact and powerful: cuts bolts, nails, rivets etc. up to Ø 4.8 mm
- > Cutting edge hardness approx. 64 HRC
- > Less physical effort due to efficient lever action mechanism
- > Slippage of cutting material reduced by lasered cutting edge
- > With gripping surface below the joint for gripping and pulling wires from Ø 1.0 mm
- > Blades with recess for easier cutting of larger cross-sections thanks to better leverage close to the fulcrum
- > Chrome vanadium heavy-duty steel, forged, multi stage oil-hardened

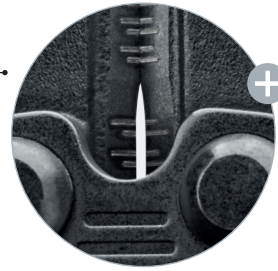

**NEW**

With recess in the cutting edge



71 31 160

**Ideal for round materials:  
the KNIPEX CoBolt® with recess**

The recess enables round materials to be placed closer to the joint when cutting. The improved leverage makes easy work of cutting through even very hard materials with less effort.

Available in lengths of  
160 mm – item no. 71 31 160  
200 mm – item no. 71 31 200  
250 mm – item no. 71 31 250



**Ideal for flat materials:  
the KNIPEX CoBolt® without recess**

The cutting edge without the recess provides optimum cutting for flat materials. The lasered cutting edge also keeps the cutting material from slipping.

Available in lengths of  
160 mm – item no. 71 01 160  
200 mm – item no. 71 01 200  
250 mm – item no. 71 01 250



Article No.	EAN 4003773-	↔ mm	Pliers	Handles	Cutting capacities				⚖ g
					Ø mm	Ø mm	Ø mm	Ø mm	
71 31 160	N 084587	160	▶▶ grey atramentized	plastic coated	5.3	4.8	3.6	3.3	195
71 31 160 SB	N 085850	160	▶▶ grey atramentized	plastic coated	5.3	4.8	3.6	3.3	195

**Properly stripped away:**  
**with deft precision, strip everything from very fine to thick cables with stranded or solid conductors**

Simple, precise stripping of fine stranded and solid round cables with a wide capacity range from 0.08 to 16 mm<sup>2</sup> with only one pair of pliers

Good grip provided by semi-circular grooved metal holding clamps and exact cut from parabolic stripping blade

Fine adjustable zero correction of the blade setting to special material requirements, e.g. due to large temperature differences

- > With cable cutter for stranded wire from 0.08 to 16 mm<sup>2</sup>
- > With tether attachment point, suitable for KNIPEX Tethered Tools accessories
- > Inscription area for customisation
- > With adjustable length stop for precision work repeated accurately each time
- > Comfortable operation with ergonomic dual-component handle
- > Easily replaceable blade cassette

**NEW**  
 PAT. PEND.



12 52 195

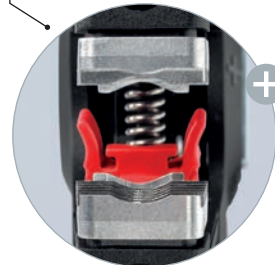

Parabolic blade separates the insulation first and then automatically pulls it back



Customisable using the inscription area

**How parabolic blades work**  
 The parabolic bulging blade pair (red) extensively encloses and cuts the insulation and is thus suitable for many flexible materials

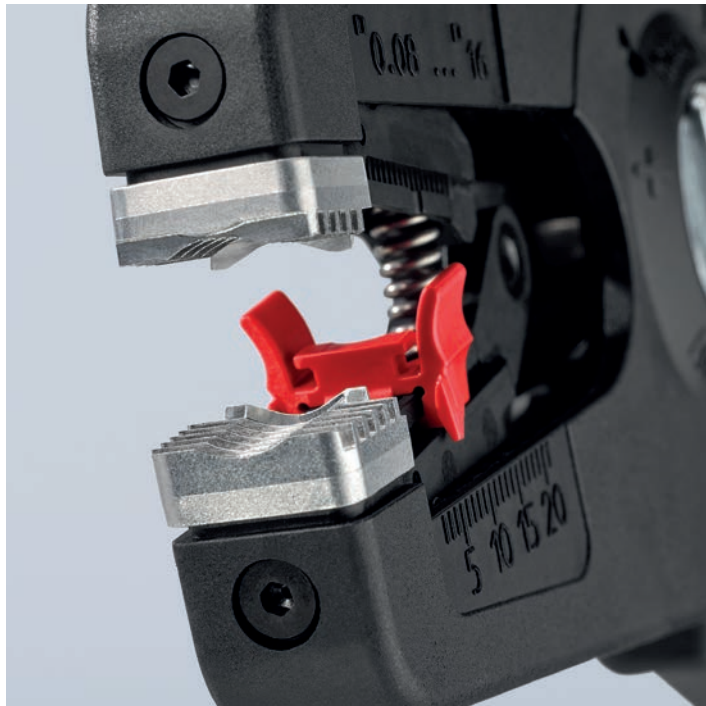

Semi-circular grooved holding clamp for better grip that holds practically any insulation material securely in place



With cable cutter on the top side for up to 16 mm<sup>2</sup>



For special requirements, such as particularly hard or soft insulation materials, optimum fine adjustments can be made using the adjustment wheel with its tactile locking positions

Article No.	EAN	↔	⊗	⊗	⚖
	4003773-	mm	mm <sup>2</sup>	AWG	g
12 52 195	<b>N</b> 085829	195	0.08 - 16	28 - 6	180
12 52 195 SB	<b>N</b> 085997	195	0.08 - 16	28 - 6	180
12 49 31	<b>N</b> 086000	Spare blade pair for 12 52 195			10



## Oil Filter and Connector Pliers

81  
1

**Now with more grip: increased grip on the workpiece thanks to two-component plastic inserts**

Fine adjustment for ideal adaptation to diverse diameters up to 75 mm

For connectors, oil filters, plastic pipes and siphons

Ideal for tightening and loosening siphon screw connections, plastic pipe fittings and round union nuts

- > For connectors and couplings with screw connection, such as Cannon circular connectors
- > For gentle loosening of hoses on nozzles and filter cartridges
- > 25-way adjustable box joint
- > Ergonomic handle geometry
- > Changeable gripping jaws with two-component plastic insert with a hard carrier component (red) and a soft adhesive component (blue)
- > Chrome vanadium electric steel, forged, oil-hardened

Now revised



81 11 250



81 13 250

Further versions from page 17



81 19 250 V01

81 19 250 V02

### New: Two components for a tighter grip

The innovative plastic inserts now consist of two components: the soft blue one "sticks" gently on the material, while the hard red one ensures the best support of the blue component

Article No.	EAN 4003773-	↔ mm	Pliers	Head	Handles	Working capacity Ø mm	Adjustment positions	⚖ g
81 11 250	078470	250	black atramentized	polished	with non-slip plastic coating	10 - 75	25	355
81 11 250 SB	078890	250	black atramentized	polished		10 - 75	25	355
81 13 250	078494	250	chrome plated			10 - 75	25	355
81 13 250 SB	078913	250	chrome plated			10 - 75	25	355
81 19 250 V01	086550	2 pairs of plastic inserts 1C for 81 11 250 / 81 13 250						5
81 19 250 V02	078500	2 pairs of plastic inserts 2C for 81 11 250 / 81 13 250						5

## Automatic Insulation Stripper

12  
64

**Work faster: Adjusts automatically to most cable types, with fine adjustment for special materials**

Strips cables with standard materials without any need for manual adjustment

Fine adjustment enables accurate setting of the blades to special materials or temperature requirements

Compact, handy and lightweight tool for common cable cross-sections and insulating materials

- > For single, multiple and fine stranded cables of 0.2 up to 6 mm<sup>2</sup> with standard insulation
- > Narrow head style for use in confined areas
- > With wire cutter for copper and aluminium wires up to 2.5 mm<sup>2</sup>
- > With adjustable length stop from 6.0 – 18.0 mm for cutting the same stripping lengths during repetitive work
- > Body: plastic, fibreglass-reinforced
- > Blades: special tool steel, oil-hardened, interchangeable



Article No.	EAN 4003773-	↔ mm	Stripping capacities		↔ mm
			mm <sup>2</sup>	AWG	
12 62 180	054573	180	0.2 - 6	24 - 10	180



## Pipe Cutter for plastic composite pipes

90

**Clean cut: cuts aluminium composite and plastic pipes with great precision**

For cutting composite pipes from Ø 12 - 25 mm

Clean, smooth and burr-free cut surfaces

Easily exchangeable blades

- > With opening spring and locking device
- > Ergonomically shaped handles made of fibreglass-reinforced plastic
- > Not suitable for cutting cables
- > Blade made of high-strength special grade steel, oil-hardened and tempered



Article No.	EAN 4003773-	↔ mm	Cutting capacities Ø mm	⚖ g
90 25 185	084839	185	12 - 25	175
90 25 185 SB	086093	185	12 - 25	175
90 29 01	031932	Spare blade		24

**NEW**



90 25 185



The high-strength, sharp blade cuts composite and plastic pipes smoothly and free of burr

## Pipe Cutter for multilayer and pneumatic hoses

90

**Perfect cutting results: the hose and pipe cutter for professional users**

Ideal for all liquid, multilayer and pneumatic hoses/pipes commonly available on the market in the wide application range from Ø 4 - 20 mm

With universal support for right-angled positioning

Easy on the hands even in continuous use thanks to low force required and automatic opening thanks to the spring mechanism

- > Easily exchangeable blades
- > With opening spring and locking device
- > Ergonomically shaped handles made of fibreglass-reinforced plastic
- > Not suitable for cutting cables
- > Blade made of high-strength special grade steel, oil-hardened and tempered



Article No.	EAN 4003773-	↔ mm	Cutting capacities Ø mm	⚖ g
90 10 185	084846	185	4 - 20	175
90 10 185 SB	086086	185	4 - 20	175
90 29 01	031932	Spare blade		24

**NEW**

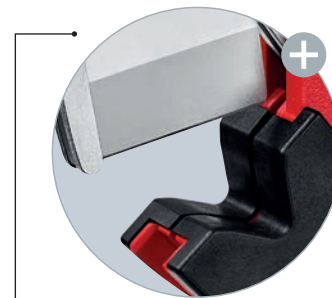

The wide support lips automatically align pipes perfectly at right angles to the blade



90 10 185



Thanks to the ergonomic handles, smooth joint and the opening spring, you can cut flexible pipes or pneumatic hoses with little effort



## Spring Hose Clamp Pliers

85  
51

- > Rotating, universal grip inserts for reliably gripping the clamps in all positions
- > Jaw inserts can also be rotated under load
- > Extremely good leverage which allows clamps to be opened easily without great effort
- > Slim head design; narrow head width, rotating grip inserts make this an ideal tool, especially in confined areas
- > Maximum jaw opening 80 mm; allows more than 40 mm clamping range
- > Can be used for standard, space-saving, spring wire hose clamps and for spring band clamps up to 70 mm nominal size



85 51 180 A

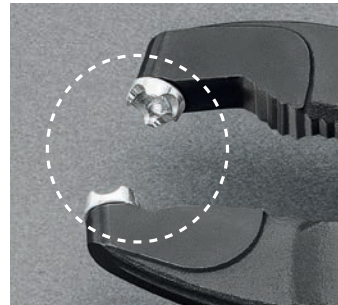

### Spring Hose Clamp Pliers with retainer



Article No.	EAN 4003773-	Adjustment positions	Capacity	↔ mm
85 51 180 A	081159	15	max. 50 mm	180
85 51 250 A	077329	25	max. 70 mm	250
85 51 250 AF	078623	19	max. 70 mm	250
85 59 250 A	077336	Spare parts assortment grip inserts		

## Hose Clamp Pliers

for Click clamps

85  
51

### To open and close Click clamps

- > Rotating jaw inserts for the safe actuation of clamps in any position
- > Good leverage which allows clamps to be opened and closed again comfortably and easily without a great deal of effort
- > For easy working on fuel hoses, vacuum pipes and suction nozzles and many other applications
- > Additional function: detach hoses gently using the serrated jaw
- > Slim head design; narrow head width, rotating grip inserts make this an ideal tool, especially in confined areas



85 51 180 C



Article No.	EAN 4003773-	Adjustment positions	↔ mm
85 51 180 C	081166	12	180
85 51 250 C	078517	14	250
85 59 250 C	078999	Spare parts assortment grip inserts	





## KNIPEX Cobra® Hightech Water Pump Pliers

87  
0

- > Push the button for adjustment on the workpiece
- > Fine adjustment for optimum adaptation to different sizes of workpieces and a comfortable handle width
- > Self-locking on pipes and nuts: no slipping on the workpiece and low handforce required
- > Gripping surfaces with special hardened teeth, teeth hardness approx. 61 HRC: high wear resistance and stable gripping
- > Box-joint design for high stability due to double guide
- > Reliable catching of the hinge bolt: no unintentional shifting
- > Guard prevents operators' fingers being pinched
- > Chrome vanadium electric steel, forged, multi stage oil-hardened



**KNIPEX Cobra® XL/XXL:** Greater gripping capacity but much lower weight than comparable pipe wrenches. Large gripping capacity of 95 mm, which requires a 3-inch pipe wrench.

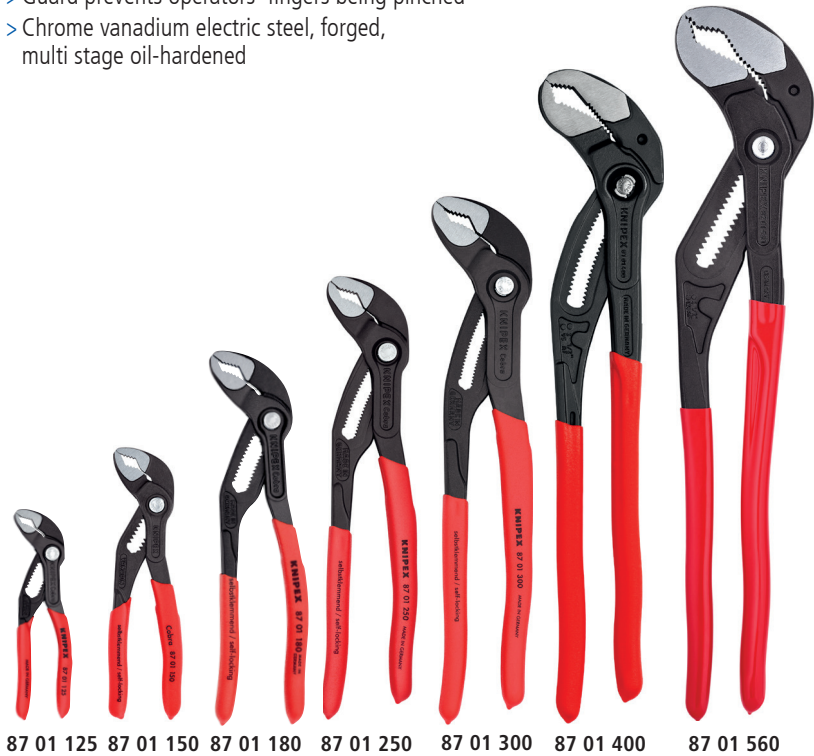

87 26 250

1000V

Article No.	EAN 4003773-	Adjustment positions	∅ Inch	∅ mm	↔ mm
87 01 125	069935	13	1	27	125
87 01 150	060116	11	1 1/4	30	150
87 01 180	022015	18	1 1/2	36	180
87 01 250	022022	25	2	46	250
87 01 300	034087	30	2 3/4	60	300
87 01 400	005636	27	3 1/2	95	400
87 01 560	044321	20	4 1/2	120	560
87 26 250	071495	24	2	46	250

## KNIPEX Cobra® QuickSet Hightech Water Pump Pliers

87  
2

**Fully open, push, grab!**

**Additional fast adjustment on the workpiece by sliding the pliers handle**

- > Combines the proven, reliable locking of the hinge bolt with an additional push function which makes it easier to work in very confined and inaccessible areas
- > The adjustment directly on the workpiece is possible by simply sliding the pliers handle
- > Reliable locking of the hinge bolt with the first workload.
- > The gripping width of the pliers is then fixed and can only be adjusted by pressing the button
- > To re-activate the sliding function, the hinge bolt must be released by pressing the push button and the pliers must be completely opened again

### 87 22 250

- > With slim two-colour multi-component sleeves without collar for better handling and easier transport

Article No.	EAN 4003773-	Adjustment positions	∅ Inch	∅ mm	∅ mm	↔ mm
87 21 250	072775	25	2	50	46	250
87 21 300	078524	25	2 3/4	70	60	300
87 22 250	077794	25	2	50	46	250



PATENTED

QuickSet

87 21 250



Press the button – open pliers completely



Position jaw – simply slide and close pliers



Hinge bolt locks itself with the first workload

## KNIPEX Cobra® ES

Water Pump Pliers extra-slim

87  
5

- > Particularly good access to the workpiece due to very slim construction of head and joint area
- > Ideal for service, maintenance and equipment repair, in automotive and general industry
- > Long, narrow jaws



Article No.	EAN	Adjustment positions	Ø Inch	Ø mm	↔ mm
87 51 250	4003773-061267	19	1 1/4	34	250



## KNIPEX SmartGrip®

Water Pump Pliers with automatic adjustment

85

- > Ideal for frequent changeovers to workpieces of different sizes
- > Automatic adjustment per one-hand operation both for right-handed and left-handed use
- > Good access to the workpiece thanks to the slim dimensions of head and joint area and flush joint bolt
- > Self-locking on pipes and nuts: no slipping on the workpiece and low handforce required
- > Gripping surfaces with special hardened teeth, teeth hardness approx 61 HRC: high wear resistance and stable gripping
- > Box-joint design for high stability due to double guide
- > Locking lever for space saving transport with reliable closed handles

Article No.	EAN	Ø Inch	Ø mm	mm	↔ mm
85 01 250	4003773-061304	1 1/4	32	36	250



Adjustment to suit the workpiece is automatic with the KNIPEX SmartGrip®! Place the outer jaw on the workpiece, squeeze the handles - turn!

## Multiple Slip Joint Spanner

87  
4

- > Replaces a set of wrenches, ideal for tightening locknuts
- > Zero-backlash gripping of metric or imperial hexagonal headed screws, no rounding of bolt heads
- > For metric and imperial nuts and screws with widths across flats from 10 to 32 mm (3/8" up to 1 1/4")
- > Reliable and tight gripping of rounded, rusty, or thick coated bolts and screws



PATENTED



Article No.	EAN	Adjustment positions	Ø Inch	mm	↔ mm
87 41 250	4003773-054566	15	3/8 - 1 1/4	10 - 32	250



## KNIPEX Alligator®

Water Pump Pliers

88

- > Self-locking on pipes and nuts: no slipping on the workpiece and low handforce required
- > Gripping surfaces with special hardened teeth, teeth hardness approx. 61 HRC: high wear resistance and stable gripping
- > Box-joint design for high stability due to double guide

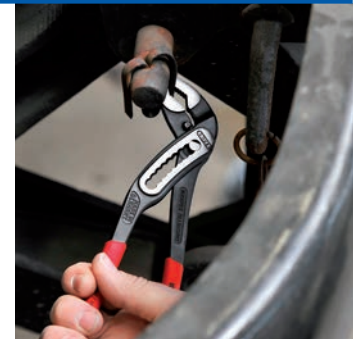

88 01 250

Article No.	EAN 4003773-	Adjustment positions	∅ Inch	∅ mm	mm	↔ mm
88 01 180	035480	9	1 1/2	42	36	180
88 01 250	022992	9	2	50	46	250
88 01 300	034094	9	2 3/4	70	60	300

More output and comfort compared to conventional water pump pliers of the same length: 9-notch adjustment positioning for 30 % more gripping capacity

## KNIPEX Alligator® XL

88

The classic model, also in 400 mm length

- > 11-notch adjustment positioning with a gripping capacity up to 3 1/2"
- > Robust adjustment mechanism, insensitive to dirt, easy to clean; particularly suitable for outdoor work
- > Good access to the workpiece due to slim size of head and joint area
- > Self-locking on pipes and nuts: no slipping on the workpiece and low handforce required
- > Gripping surfaces with special hardened teeth, teeth hardness approx. 61 HRC: high wear resistance and stable gripping
- > Box-joint design for high stability due to double guide
- > Guard prevents operators' fingers being pinched
- > Chrome vanadium electric steel, forged, multi stage oil-hardened



Article No.	EAN 4003773-	Adjustment positions	∅ Inch	∅ mm	mm	↔ mm
88 01 400	075844	11	3 1/2	90	95	400

## KNIPEX Cobra® Set

Water Pump Pliers

00

20

- > Pliers grey atramentized, handles with non-slip plastic coating

## KNIPEX Alligator® Set

Water Pump Pliers

00

20

- > Pliers with polished heads; handles with non-slip plastic coating

## Bestseller Set

00

20

- > Pliers with polished heads; handles with non-slip plastic coating and with two-colour multi-component grips

Article No.	EAN 4003773-	Content
00 20 09 V02	074793	87 01 180 87 01 250 87 01 300

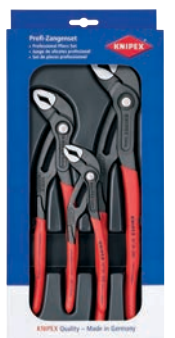

Article No.	EAN 4003773-	Content
00 20 09 V03	074809	88 01 180 88 01 250 88 01 300

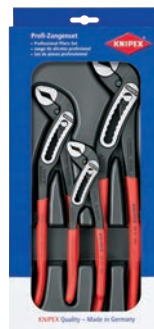

Article No.	EAN 4003773-	Content
00 20 09 V01	073994	03 02 180 70 02 160 87 01 250



For oil filters, tube fittings and connectors up to 80 mm diameter  
 Fine adjustment for ideal adjustment to diverse diameters  
 Robust, heavy duty

- > Ideal for tightening and loosening siphon screw connections, plastic pipe fittings and round union nuts
- > For connectors and couplings with screw connection, such as Cannon circular connectors
- > For gentle loosening of hoses on nozzles and filter cartridges
- > 25 adjustment positions, box-joint design
- > Ergonomic handle geometry
- > Chrome vanadium electric steel, forged, oil-hardened

**81 01 250 / 81 03 250**

- > With serrated gripping jaws; up to Ø 80 mm

**81 11 250 / 81 13 250**

- > With exchangeable plastic jaws for sensitive surfaces; up to Ø 75 mm



**New: Two components for a tighter grip**

The innovative plastic inserts now consist of two components: the soft blue one "sticks" gently on the material, while the hard red one ensures the best support of the blue component



81 01 250

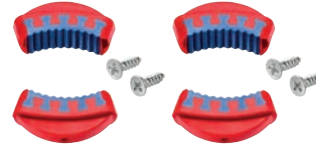

81 19 250 V02



Article No.	EAN 4003773-		Pliers	Working Capacity Ø mm	Adjustment positions	↔ mm
81 01 250	078463		black atramentized, head polished	25 – 80	25	250
81 03 250	078487		chrome plated	25 – 80	25	250
81 11 250	078470		black atramentized, head polished	10 – 75	25	250
81 13 250	078494		chrome plated	10 – 75	25	250
81 19 250 V01	086550		2 pairs of plastic inserts 1C for 81 11 250 / 81 13 250			
81 19 250 V02	078500		2 pairs of plastic inserts 2C for 81 11 250 / 81 13 250			

**KNIPEX TwinKey®**  
Control Cabinet Keys

10 profiles 2 crosses 1 key.  
 All common locking systems.

- > Multifunctional key for the actuation of locking systems from the areas of facilities engineering (heating and sanitation, air conditioning, electro technology), gas and water supply and shut-off-systems
- > 8-arm version: two 4-way spider keys connected in a space-saving way using magnets
- > Reversible bit: 1.0 x 7 mm slot and PH2 cross slot
- > Key and reversible bit joined by stable stainless steel wire
- > Weight-optimised zinc die-cast design



PATENTED

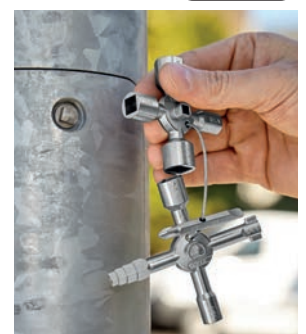

Article No.	EAN 4003773-	mm	mm	Ø mm	mm	mm	↔ mm
00 11 01	074670	5 / 6 – 7 / 8 – 9 / 10 – 11	7 – 8 / 9 – 10 / 11 – 12	3 – 5	6	6 – 9	92



Pliers and a wrench in a single tool

Replaces the need for sets of metric and imperial spanners

- > Adjustable tightening tool
- > Parallel jaws give a more solid grip; its design allows flexible adjustment of all widths up to the specified maximum size
- > Also excellent for gripping, holding, pressing and bending workpieces
- > Smooth jaws for damage free installation of plated fittings - working directly on chrome!
- > Zero backlash jaw pressure prevents damage to edges of sensitive components
- > Lever transmission greater than 10 : 1 for strong gripping power

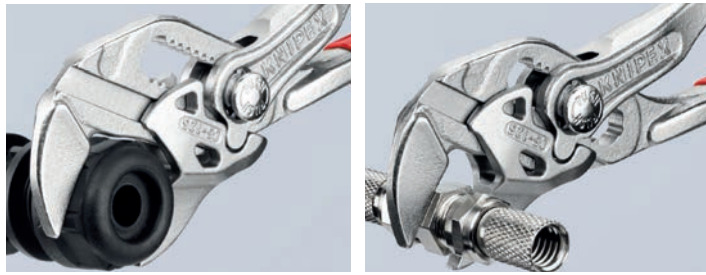

Article No.	EAN 4003773-	Adjustment positions	Inch	mm	mm
86 03 125	077497	11	7/8	23	125
86 03 150	069676	14	1	27	150
86 03 180	035466	15	1 1/2	40	180
86 03 250	033837	19	2	52	250
86 03 300	041429	24	2 1/2	68	300
86 05 150	069928	14	1	27	150
86 05 180	047162	15	1 1/2	40	180
86 05 250	047841	19	2	52	250
86 43 250	081296	17	1 3/4	46	250



86 03 180



86 05 180

New and upgraded Version on p. 6



86 43 250  $\sphericalangle 15^\circ$

Pliers Wrench, angled shape (86 43 250):  
Due to the 15° angled handles, the universal in use pliers wrench creates the necessary space for fingers and knuckles

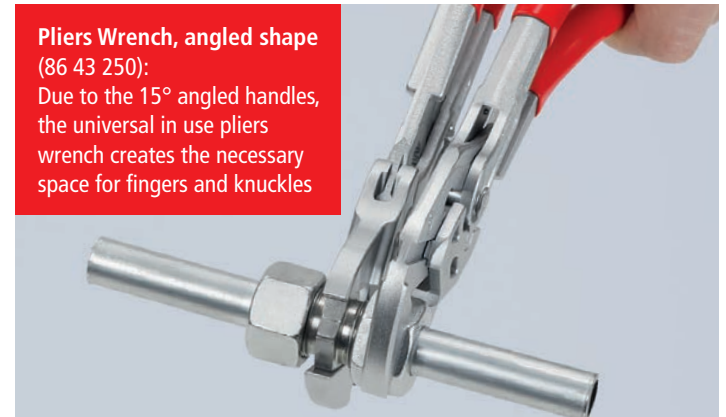

Pliers Wrench XL

Pliers and a wrench in a single tool

- > Adjustable tightening tool; also excellent for gripping, holding, pressing and bending workpieces – replaces diverse expensive, large open-end wrenches up to AF 85 mm or 3 3/8"
- > Smooth jaws, for damage free installation of quality union joints made from brass, red brass or stainless steel
- > Zero backlash jaw pressure prevents damage to edges of sensitive components
- > Push the button for adjustment on the workpiece

Article No.	EAN 4003773-	Adjustment positions	Inch	mm	mm
86 03 400	077312	25	3 3/8	85	400



The unique installation tool now also in 400 mm length.  
For opening widths up to 85 mm / 3 3/8"

Set of pliers wrenches

5-piece

- > Tool roll made of hard-wearing polyester fabric
- > With hook and loop fastener

Article No.	EAN 4003773-	Content
00 19 55 S4	077817	86 03 125 / 86 03 150 / 86 03 180 / 86 03 250 / 86 03 300
00 19 55 S4 LE	077824	Tool Roll for pliers wrenches, empty



00 19 55 S4



00 19 55 S4 LE

# Precision Circlip Pliers

With inserted tips  
for reliable work





# Precision Circlip Pliers

With inserted tips for reliable work

Heavy duty in continuous operation: up to 10 times longer service life compared to turned tips

- > Large contact faces on the tips: no distortion of circlips
- > Inserted tips: spring steel wire, drawn
- > Bolted joint: precise, zero backlash operation of pliers



48 11 J2



48 21 J21  $\angle 90^\circ$

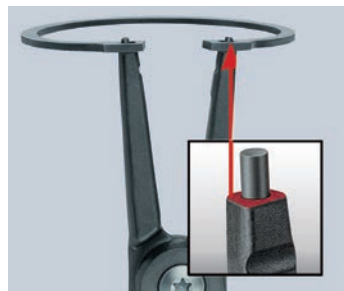

Circlips are held reliably: large contact areas and the position of the tips make it difficult for the circlip to bounce off

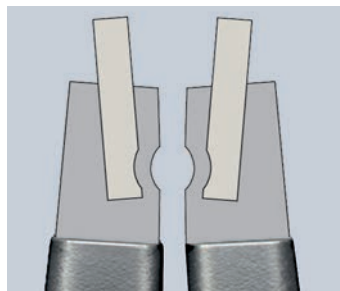

Form-fitting inserted and pressed-in tips made of high-density spring steel offer a high level of protection against excessive stress and strain



48 31 J3



48 41 J11

48

Precision Circlip Pliers for internal circlips in bore holes

Article No.	EAN 4003773-	Description	Size of bore Ø mm	Tips Ø mm	↔ mm
48 11 J0	048510	straight tips	8 – 13	0.9	140
48 11 J1	048527	straight tips	12 – 25	1.3	140
48 11 J2	048534	straight tips	19 – 60	1.8	180
48 11 J3	048541	straight tips	40 – 100	2.3	225
48 11 J4	048558	straight tips	85 – 140	3.2	320
48 21 J01	048619	90° angled tips	8 – 3	0.9	130
48 21 J11	048633	90° angled tips	12 – 25	1.3	130
48 21 J21	048640	90° angled tips	19 – 60	1.8	165
48 21 J31	048657	90° angled tips	40 – 100	2.3	210
48 21 J41	048664	90° angled tips	85 – 140	3.2	305

49

Precision Circlip Pliers for external circlips on shafts

Article No.	EAN 4003773-	Description	Size of bore Ø mm	Tips Ø mm	↔ mm
49 11 A0	048718	straight tips	3 – 10	0.9	140
49 11 A1	048725	straight tips	10 – 25	1.3	140
49 11 A2	048732	straight tips	19 – 60	1.8	180
49 11 A3	048749	straight tips	40 – 100	2.3	225
49 11 A4	048756	straight tips	85 – 140	3.2	320
49 21 A01	048817	90° angled tips	3 – 10	0.9	130
49 21 A11	048824	90° angled tips	10 – 25	1.3	130
49 21 A21	048831	90° angled tips	19 – 60	1.8	165
49 21 A31	048848	90° angled tips	40 – 100	2.3	210
49 21 A41	048855	90° angled tips	85 – 140	3.2	305

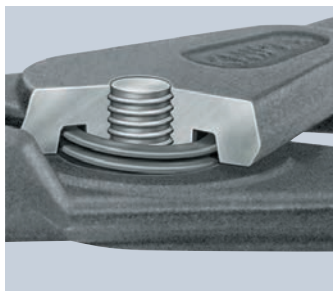

Spring inside the joint: the spring is protected inside the precisely bolted joint. It does not hinder work and cannot get dirty or lost.



48 31 J1/J2 and 49 31 A1/A2: With over-expansion guard (adjustable using end stop), Excessive expansion of rings is effectively prevented.

48

Precision Circlip Pliers for internal circlips in bore holes

Article No.	EAN 4003773-	Description	Size of bore Ø mm	Tips Ø mm	↔ mm
48 31 J0	048619	straight tips	8 - 13	0.9	180
48 31 J1	073864	straight tips	12 – 25	1.3	140
48 31 J2	073871	straight tips	19 – 60	1.8	180
48 41 J01	079569	90° angled tips	8 - 13	0.9	130
48 41 J11	079576	90° angled tips	12 - 25	1.3	130
48 41 J21	080695	90° angled tips	19 - 60	1.8	165
48 41 J31	079590	90° angled tips	40 - 100	2.3	210

49

Precision Circlip Pliers for external circlips on shafts

Article No.	EAN 4003773-	Description	Size of bore Ø mm	Tips Ø mm	↔ mm
49 31 A0	061748	straight tips	3 - 10	0.9	140
49 31 A1	073895	straight tips	10 - 25	1.3	140
49 31 A2	073901	straight tips	19 - 60	1.8	180
49 31 A3	073918	straight tips	40 - 100	2.3	225
49 41 A01	061755	90° angled tips	3 - 10	0.9	130
49 41 A11	079606	90° angled tips	10 - 25	1.3	130
49 41 A21	079613	90° angled tips	19 - 60	1.8	165
49 41 A31	079620	90° angled tips	40 - 100	2.3	210

## Circlip Pliers

for internal circlips in bore holes

44



44 11 J2

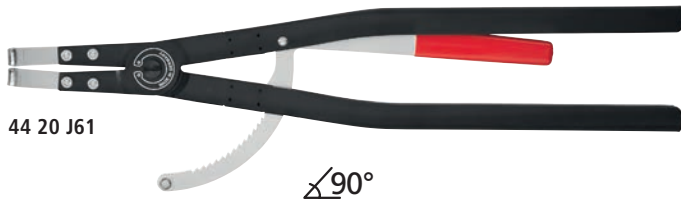

44 20 J61



46

## Circlip Pliers

for external circlips on shafts



46 11 A2



46 10 A5



46 11 A2



46 21 A2

Article No.	EAN 4003773-	Description	Size of bore Ø mm	Tips Ø mm	↔ mm
44 11 J0	040286	pliers black atramentized. head	8 – 13	0.9	140
44 11 J1	022862	polished. handles plastic coated;	12 – 25	1.3	140
44 11 J2	022879	DIN 5256 C;	19 – 60	1.8	180
44 11 J3	033943	straight tips	40 – 100	2.3	225
44 11 J4	042549		85 – 140	3.2	320
44 21 J01	040132	pliers black atramentized. head	8 – 13	0.9	130
44 21 J11	022886	polished. handles plastic coated;	12 – 25	1.3	130
44 21 J21	022893	DIN 5256 D; 90° angled tips	19 – 60	1.8	170
44 21 J31	033769	∠90°	40 – 100	2.3	215
44 21 J41	043683		85 – 140	3.2	300
44 31 J02	066941	pliers black atramentized. head	8 – 13	0.9	140
44 31 J12	066958	polished. handles plastic coated;	12 – 25	1.3	140
44 31 J22	066965	45° angled tips	19 – 60	1.8	180
44 31 J32	066972	∠45°	40 – 100	2.3	225
44 31 J42	066989		85 – 140	3.2	310
44 10 J5	024910	pliers black powder coated. with	122 – 300	3.5	570
44 10 J6	024927	locking device. can be released;	252 – 400	4.5	580
		straight tips			
44 20 J51	024958	pliers black powder-coated; with	122 – 300	3.5	590
44 20 J61	024965	locking device. can be released;	252 – 400	4.5	600
		90° angled tips ∠90°			
44 19 J5	024934	1 pair of spare tips for			
		44 10 J5			
44 19 J6	024941	1 pair of spare tips for			
		44 10 J6			
44 29 J51	024972	1 pair of spare tips for			
		44 20 J51			
44 29 J61	024965	1 pair of spare tips for			
		44 20 J61			

Article No.	EAN 4003773-	Description	Size of bore Ø mm	Tips Ø mm	↔ mm
46 11 A0	033950	pliers black atramentized. head	3 – 10	0.9	140
46 11 A1	022909	polished. handles plastic coated;	10 – 25	1.3	140
46 11 A2	022916	DIN 5254 A; straight tips	19 – 60	1.8	180
46 11 A3	033974	∠	40 – 100	2.3	210
46 11 A4	042532		85 – 140	3.2	320
46 21 A01	033967	pliers black atramentized. head	3 – 10	0.9	125
46 21 A11	023005	polished. handles plastic coated;	10 – 25	1.3	125
46 21 A21	022923	DIN 5254 B; 90° angled tips	19 – 60	1.8	170
46 21 A31	033981	∠90° ∠	40 – 100	2.3	200
46 21 A41	039365		85 – 140	3.2	300
46 31 A02	066996	pliers black atramentized. head	3 – 10	0.9	130
46 31 A12	067009	polished. with locking device.	10 – 25	1.3	130
46 31 A22	067016	can be released; 45° angled tips	19 – 60	1.8	185
46 31 A32	067023	∠45° ∠	40 – 100	2.3	210
46 31 A42	067030		85 – 140	3.2	310
46 10 A5	024996	pliers black powder-coated; head	122 – 300	3.5	560
46 10 A6	025009	polished; handles plastic coated;	252 – 400	4.5	570
		straight tips			
46 20 A51	025023	pliers black powder-coated. with	122 – 300	3.5	570
46 20 A61	025030	locking device. can be released;	252 – 400	4.5	580
		90° angled tips ∠90°			
46 19 A5	024316	1 pair of spare tips for			
		46 10 A5			
46 19 A6	025016	1 pair of spare tips for			
		46 10 A6			
46 29 A51	025047	1 pair of spare tips for			
		46 20 A51			
46 29 A61	025054	1 pair of spare tips for			
		46 20 A61			



## Special Retaining Ring Pliers

For retaining rings on shafts

45

- > For fitting horseshoe-shaped spring retaining rings and circlips without grip holes
- > For shaft retaining devices
- > With opening spring
- > Chrome vanadium electric steel, forged, oil-hardened

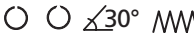
Article No.	EAN 4003773-		↔ mm
45 10 170	017370		170
45 21 200	031208		200



**45 10 170:**

- > For retaining rings with a minimum ring split gap of 3.6 mm



**45 21 200:**

- > Angled jaws with centering hole; for snap rings larger than 12.0 mm dia., e.g. for cardan shafts in a motor vehicle; minimum ring split gap of the rings 2.2 mm

## Precision Circlip Pliers Set

00  
21

- > High-quality, impact-resistant plastic case
- > Contains common Precision Circlip Pliers for highest requirements
- > Precisely-sized recesses for holding the pliers
- > Clearly organised storage of tools

Article No.	EAN 4003773-	Content
00 21 25	050131	1 x 48 11 J1 1 x 48 11 J2 1 x 48 21 J11 1 x 48 21 J21 1 x 49 11 A1 1 x 49 11 A2 1 x 49 21 A11 1 x 49 21 A21



## Circlip Pliers Sets

00  
20

- > Contains common Precision Circlip Pliers for highest requirements
- > Sturdy plastic packaging, also suitable for storage of the pliers

00 20 04 V01



00 20 03 V02



00 20 03 SB



00 20 04 SB



Article No.	EAN 4003773-	Content
00 20 03 SB	050100	1 x 48 11 J1, 48 11 J2, 49 11 A1, 49 11 A2
00 20 03 V02	077640	1 x 44 11 J1, 44 11 J2, 46 11 A1, 46 11 A2
00 20 04 SB	062417	1 x 48 11 J1, 48 11 J2, 49 11 A1, 49 11 A2, 48 21 J11, 48 21 J21, 49 21 A11, 49 21 A21
00 20 04 V01	077633	1 x 44 11 J1, 44 11 J2, 46 11 A1, 46 11 A2, 44 21 J11, 44 21 J21, 46 21 A11, 46 21 A21

## Pliers Sets

in a foam tray

00  
20

- > In a foam tray for workbenches and tool trolleys
- > Clearly organised storage of tools
- > Precisely-sized recesses for holding the pliers
- > Foam tray dimensions (W x H x D): 335 x 165 x 33 mm
- > Material: two colour, closed pore foam



00 20 01 V02

Circlip Pliers Set



00 20 01 V15

Pliers Set "Basic"



00 20 01 V16 Pliers Set "Automotive"



00 20 01 V17

Pliers Set "Basic Chrome"

Article No.	EAN 4003773-	Content
00 20 01 V02	069652	1 x 48 11 J1, 48 11 J2, 48 21 J21, 49 11 A1, 49 11 A2, 49 21 A21
00 20 01 V15	081586	1 x 03 02 180, 26 12 200, 74 02 180, 87 01 250
00 20 01 V16	081593	1 x 08 21 145, 74 01 180, 28 71 280, 28 81 280
00 20 01 V17	081944	1 x 03 05 180, 26 15 200, 74 05 180, 87 05 250

## Circlip Pliers Sets - 4 and 8 parts

00  
19

- > Tool roll made of hard-wearing polyester fabric
- > With practical, adjustable quick release fastener

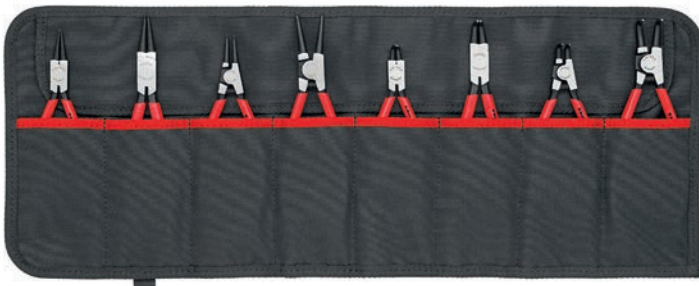

00 19 58 V01

- > Eight common Circlip Pliers for internal and external circlips



00 19 56 V01

- > Four common Circlip Pliers for internal and external circlips



00 19 57 V01

- > Four common Precision Circlip Pliers for highest requirements



00 19 58 V02

- > Eight common Precision Circlip Pliers for highest requirements

Article No.	EAN 4003773-	Content
00 19 56 V01	081548	1 x 44 11 J1, 44 11 J2, 46 11 A1, 46 11 A2
00 19 58 V01	081562	1 x 44 11 J1, 44 21 J2, 44 21 J11, 44 21 J21, 46 11 A1, 46 11 A2, 46 21 A11, 46 21 A21
00 19 57 V01	081555	1 x 48 11 J2, 44 21 J21, 49 11 A2, 49 21 A21
00 19 58 V02	081579	1 x 48 11 J1, 48 11 J2, 48 21 J11, 48 21 J21, 49 11 A1, 49 11 A2, 49 21 A11, 49 21 A21



## Ear Clamp Pliers

10

Suitable for universal use, for 1-ear and 2-ear clamps (Oetiker system or similar)

- > For the simple and reliable mounting of 1-ear and 2-ear clamps (Oetiker system or similar)
- > No damage to press points on the ear clamps
- > The slim head permits good accessibility in confined areas
- > Versatile use for clamps on CV boots, cooler and fuel lines, air pressure systems, compressors
- > Durable and strong
- > High-grade special tool steel, forged, oil-hardened

### 10 99 I220

- > Especially suitable for universal use thanks to the additional side jaw



10 98 I220



10 99 I220

Article No.	EAN	Description	↔ mm
10 98 I220	4003773-080749	pliers black atramentized, head polished, handles plastic coated	220
10 99 I220	080756		220

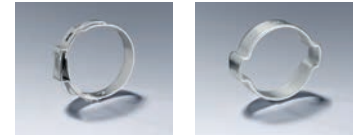

Using the front press nib



10 99 I220: Using the side press nib



10 98 I220: Sealing the hose connection on central lubrication



10 99 I220: Sealing the fluid hose on the connecting piece

## Halogen Bulb Exchange Pliers

30  
41

- > For the installation of wedge base bulbs
- > Gripping surfaces plastic coated



Article No.	EAN	Description	↔ mm
30 41 160	4003773-048480	head polished; handles plastic coated, Chrome vanadium electric steel, forged, oil-hardened	160

## Upholstery Pliers

91

- > For the professional fixing of seat covers on profiled seats to the seat frame with all popular upholstery clips
- > Securely insert upholstery clips, guide and hold: the special groove fixes the upholstery clips in the correct position
- > Easy positioning of the upholstery clips: a closing spring holds the pliers closed, the clip can be securely positioned and pressed
- > Upholstery clips can be easily pressed together due to a good transmission ratio of the pliers
- > User-friendly operation thanks to multi-component grips

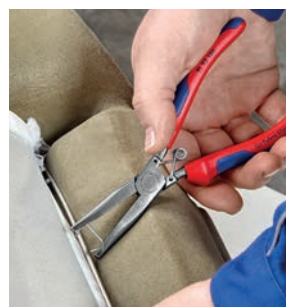

Article No.	EAN	Description	↔ mm
91 92 180	4003773-080725	head polished; handles with multi-component grips	185

## Long Reach Needle Nose Pliers

DIN ISO 5743, with transverse profiles

28

### Special Long Reach Needle Nose Pliers with transverse profiles

For gripping, adjustment and assembly work in hard to reach areas thanks to slim, very long design

Deep parts can be easily reached using the slim, half-round tips

- > Careful yet reliable gripping, holding and guiding of small copper pipes, screws and cables as well as other round parts thanks to milled grooves with smooth surfaces
- > Serrated pipe grip to grip round parts
- > Particularly suitable for work in the automotive trade and in mechanical engineering
- > Slim yet robust tool; forged from special tool steel, oil-hardened and tempered



28 71 280



28 81 280  $\angle 45^\circ$

Article No.	EAN 4003773-	Description	$\longleftrightarrow$ mm
28 71 280	079415	head polished; handles plastic coated	280
28 81 280	079422	head polished; handles plastic coated, 45°	280

## Needle-Nose Combination Pliers

08

### Small High Leverage Combination Pliers with pointed jaw For all common installation and repair work

Handy use when working in confined areas thanks to slim head design and pointed jaws (anti-twist)

Gripping surfaces with special convex contour on one side for secure gripping of flat parts

Milled groove in the gripping area permits small parts such as nails, pins and bolts to be held and pulled

- > The reliable and diverse combination pliers when out and about
- > Easy cutting thanks to the high leverage joint
- > With cutting edges for soft, medium-hard and hard wire
- > Long service life and stable tips; forged from special high grade tool Steel, manifold oil-hardened

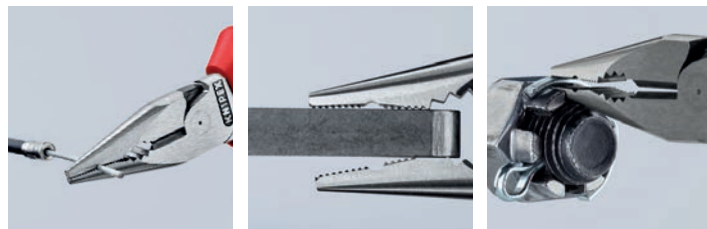

Milled groove in the gripping area

Firm grip also on flat material due to three-point rest

Tip keeps its shape even during greater torsional forces



08 21 145



08 22 145



08 25 145



08 26 145





Article No.	EAN 4003773-	$\bigcirc$ mm	$\bullet$ mm	$\odot$ mm	$\oplus$ mm <sup>2</sup>	$\longleftrightarrow$ mm
08 21 145	078951	3.0	2.0	8.0	16	145
08 22 145	078968	3.0	2.0	8.0	16	145
08 25 145	078975	3.0	2.0	8.0	16	145
08 26 145	079361	3.0	2.0	8.0	16	145



## Combination Pliers

03

- > With gripping zones for flat and round material, suitable for versatile use
- > With cutting edges for soft and hard wire
- > Cutting edges additionally induction hardened, cutting edge hardness approx. 60 HRC
- > Special tool steel, forged, oil-hardened

Article No.	EAN 4003773-	 Ø mm	 Ø mm	 Ø mm	 mm <sup>2</sup>	 mm
03 02 160	023203	3.1	2.0	10	16	160
03 02 180	023197	3.4	2.2	12	16	180
03 06 180	021926	3.4	2.2	12	16	180
03 02 200	034940	3.8	2.5	13	16	200



03 06 180

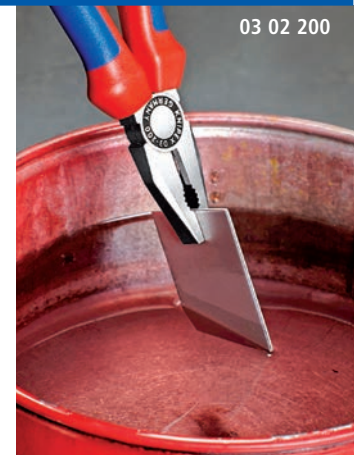

03 02 200

## Mechanics' Pliers

38

- > High bending strength of the pliers tips
- > Gripping surfaces cross-hatched, knurled
- > Vanadium electric steel; forged, oil-hardened



Article No.	EAN 4003773-	Description	 mm
38 11 200	035169	head polished, handles plastic coated	200
38 21 200	035176	head polished, handles plastic coated; 40°	200
38 31 200	040712	head polished, handles plastic coated	200
38 71 200	017202	head polished, handles plastic coated; 70° angled, half-round jaws, suitable for pulling split pins; for gripping at points that are difficult to access	200
38 91 200	017219	head polished, handles plastic coated; 45° angled, half-round, long jaws, also suitable for gripping spark plugs and round components (spark plug cover "grabber")	200



Gentle loosening of hoses in confined areas

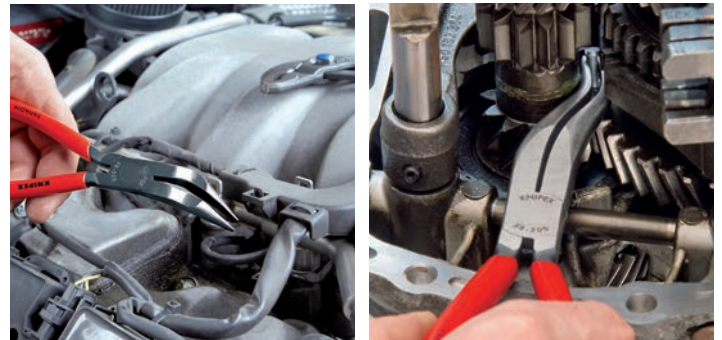

## Snipe Nose Side Cutting Pliers

(Radio Pliers)

25

- > Suitable for finer gripping and cutting work
- > Pointed, half-round jaws
- > Knurled gripping surfaces
- > With cutting edges for soft, medium-hard and hard wire
- > Cutting edges additionally induction hardened, cutting edge hardness approx. 61 HRC
- > Vanadium electric steel; forged, oil-hardened

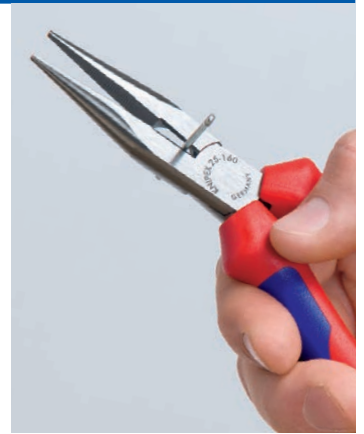

Article No.	EAN 4003773-	Description	↔ mm
25 02 140	023159	head polished, handles with multi-component grips	140
25 02 160	023166	head polished, handles with multi-component grips	160
25 21 160	015994	head polished, handles plastic coated	160

## Snipe Nose Side Cutting Pliers

(Stork Beak Pliers)

26

Elastic tips: dimensionally stable even when twisted

- > Distortion-tolerant, elastic precision tips
- > Half-round, long, pointed jaws
- > Vanadium electric steel; forged, oil-hardened

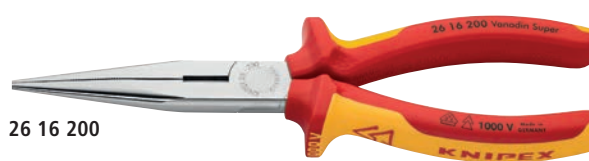
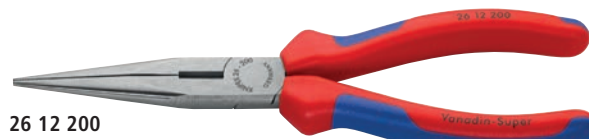

Article No.	EAN 4003773-	Description	↔ mm
26 12 200	023142	head polished, handles with multi-component grips	200
26 22 200	023135	40° angled; head polished, handles with multi-component grips	200
26 16 200	022831	pliers chrome plated; handles insulated with multi-component grips, VDE-tested	200

## Long Nose Pliers

30

- > Heavy-duty and hard-wearing gripping pliers
- > Different jaw styles
- > Chrome vanadium electric steel, forged, oil-hardened



Article No.	EAN 4003773-	Description	↔ mm
30 11 160	023128	head polished, handles plastic coated; long, trapezoidal jaws, knurled gripping surfaces	160
30 21 160	035053	head polished, handles plastic coated; long, half-round jaws, knurled gripping surfaces	160
30 31 160	035077	head polished, handles plastic coated; long, round jaws, smooth gripping surfaces	160



## Grip Pliers

41

- > Hold round, profile and flat material securely
- > Heavy duty model
- > With adjustment screw and release lever
- > One-hand operation
- > High clamping pressure due to toggle lever action



41 04 250



41 34 165



## Welding Grip Pliers

42

- > For gripping, clamping and holding of diverse profiles
- > Heavy duty model
- > With adjustment screw and release lever
- > One-hand operation



42 14 280



42 34 280

Article No.	EAN 4003773-	mm	mm	mm	mm
41 04 180	002741	30	20	30	180
41 04 250	002758	40	20	30	250
41 04 300	022183	65	30	34	300
41 34 165	047858	20	10	24	165

Article No.	EAN 4003773-	Description	mm	mm	mm
42 14 280	022206	also for section material with vertical webs up to 25 mm height; pliers bright zinc plated	50	30 – 65	280
42 34 280	022220	clamps cumbersome workpieces and sections with high webs up to 40 mm; pliers bright zinc plated	90		280

## Carpenters' Pincers

50

- > For heaviest duty
- > Extreme wear resistance and well balanced
- > Cutting edge hardness approx. 60 HRC
- > Special tool steel, forged, oil-hardened



Article No.	EAN 4003773-	Description	Ø mm	↔ mm
50 00 300	015710	pliers black atramentized, head polished	2.4	300

## Farriers' Pincers (Tear-off Pliers for vehicle bodywork)

55

- > Also suitable for dismantling work in vehicle body workshops
- > Cutting edges additionally hardened; cutting edge hardness approx. 59 HRC
- > Special tool steel, forged, oil-hardened



Article No.	EAN 4003773-	Description	Head width mm	↔ mm
55 00 300	014072	pliers black atramentized, head polished	20	300

## Concreters' Nippers

99

- > Unobtained precision and long service life make these the most widely purchased concreters' nippers in the world
- > Cutting edges additionally hardened; cutting edge hardness approx. 61 HRC
- > High-grade special tool steel, forged, oil-hardened



99 00 280

Article No.	EAN 4003773-	Description	Ø mm	Ø mm	↔ mm
99 00 220	013273	pliers black atramentized	2.4	1.6	220
99 00 250	013280	pliers black atramentized	2.4	1.6	250
99 00 280	014096	pliers black atramentized	2.8	1.8	280

## Wire Rope Cutters forged

95

- > Cuts all wire ropes without splaying, including those that are extremely strong
- > With two crimping dies for end caps on Bowden cable sheaths and end ferrules for traction cables
- > Comfortable work thanks to handy, slim design and internal opening spring
- > Bolted joint for precise blade guidance, re-adjustable
- > High leverage for reduced effort
- > Cutting-edge hardness approx. 64 HRC
- > Chrome vanadium heavy-duty steel, forged, oil-hardened

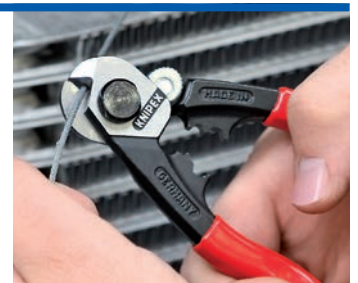

Article No.	EAN 4003773-	Ø mm	Ø mm	Ø mm	Ø mm	↔ mm
95 61 190	040651	7.0	5.0	4.0	2.5	190

New

Upgraded



29



## Wire Rope Cutters

also for high-strength wire rope

95

Compact, light and powerful

Up to 30% less physical effort compared to wire rope cutters of the same length

Double-mounted box joint design for high level of stability

- > Cutting edges additionally induction hardened, cutting edge hardness approx. 64 HRC
- > Compact at 160 mm but nevertheless more powerful than many larger wire rope cutters
- > Secured by locking device during transport
- > Ball bearing steel



Article No.	EAN 4003773-	Ø mm	Ø mm	↔ mm
95 62 160	082354	6.0	4.0	160
95 62 160 SB	082712	6.0	4.0	160



## KNIPEX CoBolt® S

Compact Bolt Cutters

71

Compact and powerful

Extremely high cutting performance in a convenient length of 160 mm

Small, slim head for excellent accessibility

- > Compact and powerful: cuts bolts, nails, rivets etc. up to Ø 4.4 mm
- > Heavy duty, induction hardened cutting edge for thin, hard wire, screws and springs. Cutting edge hardness approx. 64 HRC
- > Less physical effort due to efficient lever action mechanism



Powerful through to the tips



Slim head for ideal accessibility

Article No.	EAN 4003773-	Ø mm	Ø mm	Ø mm	Ø mm	↔ mm
71 01 160	082668	5.3	4.4	3.2	3.0	160



## KNIPEX CoBolt®

Compact Bolt Cutters

71

- > Precision cutting edges for soft and hard wire as well as piano wire
- > Cuts bolts, nails, rivets, etc. up to Ø 5.2 mm
- > Most efficient joint design ensures exceptional cutting performance
- > Cutting edges additionally induction hardened, cutting edge hardness approx. 64 HRC
- > Chrome vanadium heavy-duty steel, forged, oil-hardened

### 71 12 / 22 200

- > Opening spring and locking device are integrated in the handles also for comfortable work and protected transport

### 71 41 200

- > 20° angled head with single-sided joint bar and diagonal cutting edge for flush cutting; with space for gripping

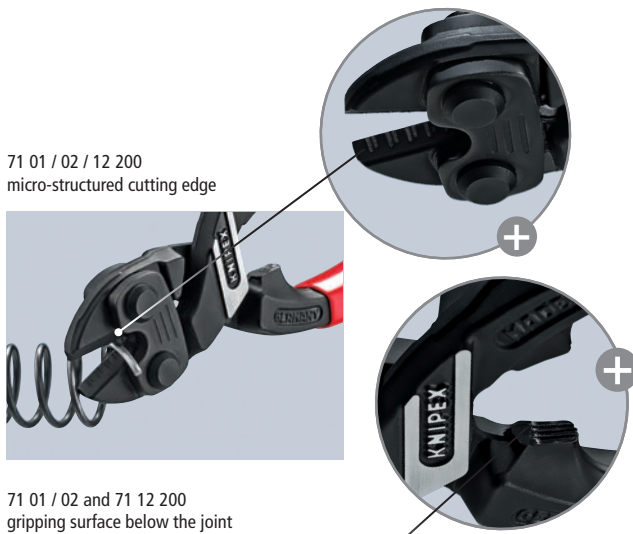

71 02 200







71 22 200  $\angle 20^\circ$



71 41 200  $\angle 20^\circ$

New:  
KNIPEX  
CoBolt® S  
(p. 9)

Article No.	EAN 4003773-		 Ø mm	 Ø mm	 Ø mm	 Ø mm	$\leftrightarrow$ mm
71 01 200	033165		6.0	5.2	4.0	3.6	200
71 02 200	047056		6.0	5.2	4.0	3.6	200
71 12 200	066859	$\text{M}$	6.0	5.2	4.0	3.6	200
71 31 200	042327		6.0	5.2	4.0	3.6	200
71 22 200	066873	$\text{M} \angle 20^\circ$	6.0	5.2	4.0	3.6	200
71 41 200	066897	$\angle 20^\circ$	6.0	5.2	4.0	3.6	200

## KNIPEX CoBolt® XL

Compact Bolt Cutters

71



The compact bolt cutters from KNIPEX now also available with long handles for one and two-hand operation.

Up to a 40-fold increase of manual force.

For powerful cutting of larger cross-sections as well as very hard materials

Two-hand operation for maximum cutting force

- > 60 % less effort required compared to high leverage diagonal cutters of the same size
- > 40-fold increase of manual force due to special joint design
- > With gripping surface below the joint for gripping and pulling wires with a diameter as from 1.0 mm

Article No.	EAN 4003773-	 Ø mm	 Ø mm	 Ø mm	$\leftrightarrow$ mm
71 01 250	079637	5.6	4.0	3.8	250
71 31 250	079644	6.0	4.3	4.2	250



71 01 250

### 71 31 250

- > Blades with recess for easier cutting of larger cross-sections thanks to better leverage close to the fulcrum



71 01 250



71 31 250

New

Upgraded



31



## Pipe Cutter

for plastic conduit pipes and hoses

90

- > For cutting thin walled plastic pipes (conduit plastic pipes) and flexible hoses, also with fabric reinforcement, of plastic and rubber up to 25.0 mm / 1" exterior dia.
- > Not suitable for cutting cables
- > With opening spring and locking device



Article No.	EAN 4003773-	Cutting capacities Ø mm	↔ mm
90 20 185	067122	25	185

## Anvil shears

95

5

Versatile, slim cutters with shear-action draw cut for the energy-saving, accurate cutting of soft and fibrous materials

- > Drawing cut against firm surface for cutting soft materials without damage, e.g. rubber profiles, PVC, leather, wood, hoses etc.
- > Cuts flat material with a max. width of 40 mm and height of 7.5 mm
- > Cutting capacity for round material up to Ø 25 mm
- > Strong, replaceable blade
- > With opening spring and locking device
- > Tool body: tool steel, rolled, oil-hardened



Anvil cut with aluminium anvil; blade and anvil can be replaced



Article No.	EAN 4003773-	Tool	Handles	Blade length mm	↔ mm
94 55 200	080763	MM	with plastic grips	40	200

## Combination Shears

95

- > For cutting cardboard, plastics, aluminium, brass and copper foils
- > Precision ground, hardened blades
- > With opening spring and locking device
- > Not suitable for steel wire or iron sheets
- > Shears body: surgical steel, stainless, vacuum-hardened
- > Handles: plastic, impact-proof



Article No.	EAN 4003773-		↔ mm
95 05 185	060277	40°	185
95 05 190	019602		190

## Diagonal Cutters

70  
0

- > The indispensable diagonal cutter for all-round use
- > High-quality material and precise workmanship for long service life
- > Precision cutting edges for soft and hard wire
- > Clean cutting of thin copper wires, also at the cutting edge tips
- > Cutting edges additionally induction hardened, cutting edge hardness approx. 62 HRC
- > Narrow head style for use in confined areas
- > Vanadium electric steel, forged, multi stage oil-hardened



Precision rivet:  
new and more stable rivet shape

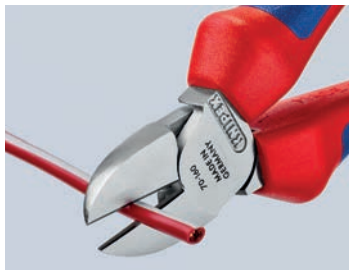





70 02 160



70 05 160



70 06 160

Article No.	EAN 4003773-	 Ø mm	 Ø mm	 Ø mm	 mm
70 02 160	034032	4.0	3.0	2.0	160
70 05 160	039600	4.0	3.0	2.0	160
70 06 160	080022	4.0	3.0	2.0	160
70 02 180	034049	4.0	3.0	2.5	180
70 05 180	043706	4.0	3.0	2.5	180
70 06 180	033813	4.0	3.0	2.5	180

## KNIPEX X-Cut®







Compact Diagonal Cutters

73  
0

Powerful, light and universal

Cuts finest strands as well as multi-core cables and piano wires

- > Box-joint design: highest stability with low weight
- > Doubly supported joint axis for heaviest duty
- > High cutting performance with minimum effort due to optimum co-ordination of the cutting edge angle and transmission ratio
- > Large opening width for thicker cables
- > Cuts precisely, even through fine copper wires
- > Compact, low-weight construction
- > Chrome vanadium heavy-duty steel, forged, multi stage oil-hardened

Article No.	EAN 4003773-	 Ø mm	 Ø mm	 Ø mm	 Ø mm	 Ø mm	 mm
73 02 160	075127	4.8	3.8	2.7	2.2	12	160
73 05 160	075134	4.8	3.8	2.7	2.2	12	160



73 05 160

(PATENTED)





- > For very tough, continuous use
- > High cutting performance with minimum effort due to optimum coordination of the cutting edge angle and transmission ratio
- > Precision cutting edges additionally induction hardened (cutting edge hardness approx. 64 HRC), for all sorts of wire including piano wire
- > Chrome vanadium heavy-duty steel, forged, multi stage oil-hardened



74 02 160



74 02 180



74 06 200

Article No.	EAN 4003773-		Ø mm	Ø mm	Ø mm	↔ mm
74 02 160	023081		3.4	2.5	2.0	160
74 02 180	023074		3.8	2.7	2.2	180
74 02 200	040309		4.2	3.0	2.5	200
74 02 250	042402		4.6	3.5	3.0	250
74 06 200	033820	⚠ 1000 V	4.2	3.0	2.5	200



## KNIPEX TwinForce® High Performance Diagonal Cutters

### The superior High Leverage Diagonal Cutter with patented double joint

- > Ideal transmission of force due to double-hinged design
- > Reliably cuts all types of wire, including steel tape
- > For rough or very fine cutting
- > Low cutting impact: gentle on hands. The tension on muscles and tendons is relieved
- > For comfortable cutting, repetitive cutting or extremely hard cutting jobs
- > High degree of stability and zero-backlash due to precisely milled forged-in axles
- > Chrome vanadium heavy-duty steel, forged, oil-hardened

#### 73 72 180 F

- > With opening spring to simplify reapplication and for repetitive cutting



73 72 180



73 71 180

Article No.	EAN 4003773-	Ø mm	Ø mm	Ø mm	Ø mm	↔ mm
73 71 180	074762	5.5	4.6	3.2	3.0	180
73 72 180	074779	5.5	4.6	3.2	3.0	180
73 72 180 F	077657	5.5	4.6	3.2	3.0	180

# KNIPEX StriX®

Insulation Stripper with Cable Shears

13

## Insulation strippers with cable shears – two essential electrical installation tools in one pair of pliers

- > Integrated cable shears for the clean cutting of Cu and Al cables without crushing
- > Universal adjustment of the wire stripping blades by means of a knurled screw
- > Slim design for good accessibility
- > For stripping single, multiple and fine stranded conductors with plastic and rubber insulation up to of Ø 5 mm or resp. 10 mm<sup>2</sup> conductor cross-section
- > Graduated jaw is a visual orientation aid when stripping wire in standard lengths (11 mm and 16 mm)
- > Special high grade tool steel that has been oil hardened in multiple stages



Induction hardened precision blade



(PAT. PEND.)

13 62 180



Induction hardened shear blade with precisely ground cutting edges for crushing-free cutting of copper cables up to Ø 15 mm (5 x 2.5 mm<sup>2</sup>)

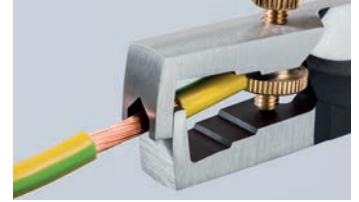

Lock nut prevents any unintentional adjustment

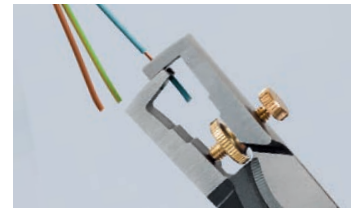

Length marking: visual markings provide support during repeated stripping of wire in standard lengths (11 and 16 mm)

Article No.	EAN 4003773-	Pliers	Head	Handles	Cutting capacities		Stripping capacities		↔ mm
					Ø mm	mm <sup>2</sup>	Ø mm	mm <sup>2</sup>	
13 62 180	081302	black atramentized	polished	with multi-component grips	15	50	5,0	10	180
13 66 180	081319	chrome plated		insulated with multi-component grips, VDE-tested	15	50	5,0	10	180

## Insulation Strippers

11

- > Or single, multiple and fine stranded conductors with plastic or rubber insulation up to Ø 5.0 mm or 10 mm<sup>2</sup>
- > Easy adjustment to the required diameter of solid or stranded wire with knurled screw and lock nut
- > Special tool steel, forged, oil-hardened

Article No.	EAN 4003773-	Pliers	Stripping capacities			↔ mm
			Ø mm	mm <sup>2</sup>	AWG	
11 05 160	039570	MM	5.0	10	8	160
11 06 160	021933	MM 1000V	5.0	10	8	160



11 06 160

## Pliers for Electrical Installation

13

### The mobile task force

Multifunctional pliers for the electrical installation; to grip flat and round material, for bending, deburring, cutting cable, stripping and crimping wire ferrules

### 6 functions in one pair of pliers

- > Smooth surfaces near the tips grip single cores without damaging them; serrated gripping surfaces and pipe grip for gripping flat and round material
- > Clear-cut outside edge on the jaw for working on flush-mounted junction boxes and deburring feed-through holes
- > Stripping holes for conductors of 0.75 – 1.5 mm<sup>2</sup> and 2.5 mm<sup>2</sup>
- > Crimp die for wire ferrules 0.5 – 2.5 mm<sup>2</sup>
- > Cable shears with (induction-hardened) precision cutting edges for copper and aluminium cables up to 5 x 2.5 mm<sup>2</sup>/Ø 15 mm
- > Slim dimensions for easy access
- > Bolted joint: precise, zero backlash operation of pliers



13 82 200

(PATENTED)

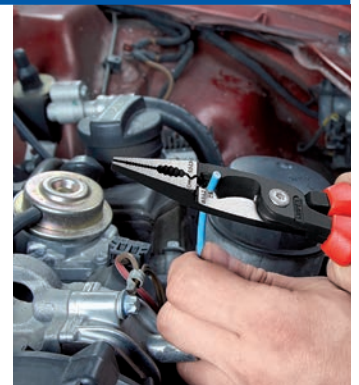





Article No.	EAN 4003773-	Pliers	Head	Handles	Cutting capacities		↔ mm
					Ø mm	mm <sup>2</sup>	
13 81 200	075240	black atramentized	polished	plastic coated	15	50	200
13 82 200	075080	black atramentized	polished	with multi-component grips	15	50	200



## Automatic Insulation Stripper

12

- > Compact standard tool at a favourable price for all current cable cross-sections and insulating materials
- > For single, multiple and fine stranded cables of 0.2 up to 6 mm<sup>2</sup> with standard insulation
- > Narrow head style for use in confined areas
- > Blades: special tool steel, oil-hardened, interchangeable

Article No.	EAN	 mm <sup>2</sup>	 AWG	 mm
12 62 180 	4003773-054573	0.2 – 6	24 – 10	180



Wire cutter for multiple stranded wire cables up to 10.0 mm<sup>2</sup>

Adjustable length stop



Precise stripping prevents damage to the conductor

## Self-Adjusting Insulation Stripper

12

- > For single, multiple and fine stranded conductors with plastic or rubber insulation
- > Cutting depth can be adjusted for different insulation materials
- > Blade: special tool steel, oil-hardened



Article No.	EAN	 mm <sup>2</sup>	 AWG	 mm
12 40 200	4003773-026662	0.03 - 10	32 – 8	200

## KNIPEX MultiStrip 10

Automatic Insulation Stripper

12

Universal blade geometry -robust and more durable

Ideal grip design with excellent haptics

Recessed wire cutter

- > Fully automatic adjustment to all single-, multi- and fine-stranded conductors with standard insulation throughout the entire capacity range from 0.03 to 10.0 mm<sup>2</sup>
- > No manual fine adjustment necessary
- > No damage to the conductors
- > The clamping jaws made of steel hold the cable in a way that prevents slipping without damaging the remaining insulation

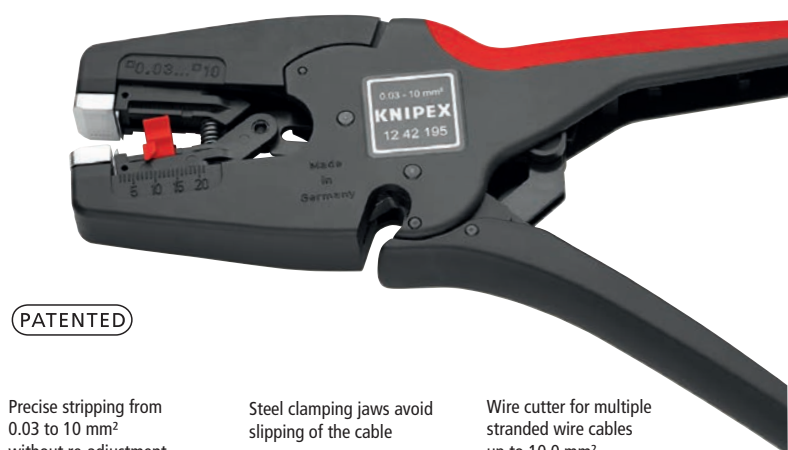

**PATENTED**

Precise stripping from 0.03 to 10 mm<sup>2</sup> without re-adjustment

Steel clamping jaws avoid slipping of the cable

Wire cutter for multiple stranded wire cables up to 10.0 mm<sup>2</sup>

Article No.	EAN	Stripping capacities mm <sup>2</sup>	AWG	 mm
12 42 195	4003773-054580	0.03 – 10	32 – 8	195

## Crimping Pliers

97  
21

- > For cutting cables, stripping wire and crimping insulated and non-insulated terminals, connectors and plug type connectors
- > With threaded holes for cutting copper and brass screws threaded M 2.6 / M 3 / M 3.5 / M 4 and M 5
- > Bolted joint for higher stability and even movement



97 21 215

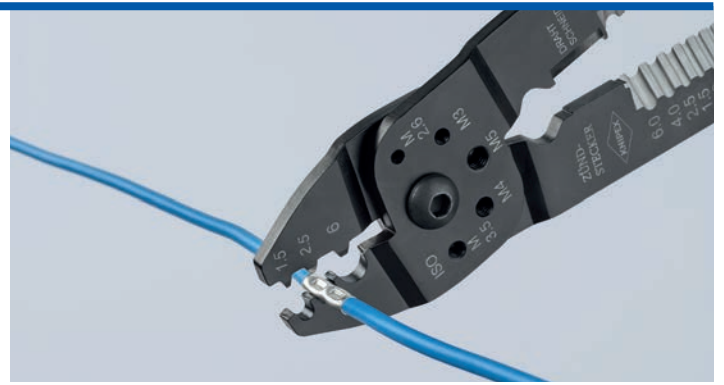

Article No.	EAN 4003773-			Capacity		↔ mm
				mm <sup>2</sup>	AWG	
97 21 215	019688			0.5 – 6	20 – 10	230
97 21 215 B	019695			0.5 – 2.5	20 – 14	230
97 21 215 C	019701			0.5 – 6	20 – 10	230

## Crimping Pliers

97  
22

- > For cutting cables, stripping wire and crimping insulated and non-insulated terminals, connectors and plug type connectors
- > With threaded holes for cutting copper and brass screws threaded M 2.6 / M 3 / M 3.5 / M 4 and M 5
- > Bolted joint for higher stability and even movement
- > Special steel, high-strength

Article No.	EAN 4003773-			Capacity		↔ mm
				mm <sup>2</sup>	AWG	
97 22 240	070726			0.5 – 6.0	20 – 10	240
				0.5 – 2.5	20 – 14	
97 32 240	079491			0.5 – 6.0	20 – 10	240
					20 – 10	



97 22 240

## KNIPEX PreciForce® Crimping Pliers

97  
52

- > Repetitive, high crimping quality due to precision dies and integral lock (self-releasing mechanism)
- > Crimping pressure has been set precisely (calibrated) in the factory, re-adjustable
- > Optimum transmission of force thanks to toggle lever for fatigue-reduced operation
- > Good handling thanks to favourable handle position, low weight, compact design and ergonomically shaped handles



97 52 36



Article No.	EAN 4003773-	Description		↔ mm
97 52 33	051862	non-insulated crimp terminals, tube and compression cable lugs in accordance with DIN 46234 and DIN 46235 and non-insulated crimp, butt and press connectors in accordance with DIN 46341 and DIN 46267		220
97 52 35	051886	non-insulated open plug type connectors (plug width 4.8 + 6.3 mm)		220
97 52 36	051893	insulated terminals, plug connectors + butt connectors		220
97 52 37	063193	Sheat shrinkable sleeve connectors		220



# KNIPEX MultiCrimp® Crimping Pliers with changer magazine

97  
33

Also for insulated and non-insulated wire ferrules  
10 / 16 / 25 mm<sup>2</sup>

## Universal indent crimping die for non-insulated connectors

- > Crimping pliers with round magazine and five interchangeable dies
- > Just one tool for the most common crimping applications
- > Crimping dies changed quickly and easily without any additional tool
- > Sorted and protected storage of the interchangeable dies in a round magazine
- > Comfortable, powerful crimping pliers in professional quality
- > Same reliable crimping results as with fixed crimping dies
- > Repetitive, high crimping quality due to precision dies and integral lock (self-releasing mechanism)

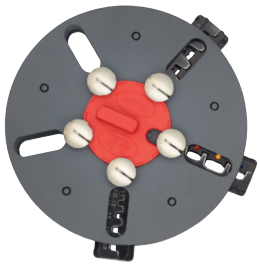

97 33 02

PATENTED



Changing position: service lever opens out for parallel jaw positioning



Changing the crimping dies: unlock the magazine position, take out the set of dies which the pliers have been pushed on



Fold in the service lever and press the pliers – ready for use again

Article No.	EAN 4003773-					Capacity mm <sup>2</sup>	AWG	↔ mm
97 33 01	066927			MM	KNIPEX MultiCrimp® non-insulated open plug type connectors (plug width 4.8 + 6.3 mm)	0.5 – 6	20 – 10	250
					insulated terminals, plug connectors and butt connectors	0.5 – 6	24 – 10	
					insulated and non-insulated wire ferrules	0.25 – 6	24 - 10	
97 33 02	066934			MM	KNIPEX MultiCrimp® non-insulated open plug type connectors (plug width 4.8 + 6.3 mm)	0.5 – 6	20 – 10	250
					insulated terminals, plug connectors and butt connectors	0.5 – 6	20 – 10	
					insulated and non-insulated wire ferrules	0.5 – 6	24 – 10	
					insulated and non-insulated wire ferrules	10 / 16 / 25	8 / 6 / 4	
					non-insulated crimp terminals, tube and compression cable lugs in accordance with DIN 46234 and DIN 46235 and non-insulated crimp, butt and press connectors in accordance with DIN 46341 and DIN 46267	0.5 – 10	20 – 8	

## Electronic Super Knips®

78

- > Precision pliers for ultra fine cutting work
- > Ground, very sharp cutting edges without bevel
- > Shear cut with controlled micro cutting edge misalignment for the most precise cutting of even the thinnest of wires and for a long service life
- > Precision shaped tips cut wires resting on a board from Ø 0.2 mm
- > Joint with stainless steel rivet
- > Cutting edges additionally induction hardened
- > Extremely smooth movement for minimum operator fatigue

Article No.	EAN 4003773-		Capacity		↔ mm
			Ø mm	Ø mm	
78 03 125	035381	⚡ 🔴 🔴 🔴	0.2 - 1.6	1.0	125
78 61 125	035404	⚡ 🔴 🔴 🔴	0.2 - 1.6	1.2	125
78 06 125	N 084099	⚡ 1000V 🔴 🔴 🔴	0.2 - 1.6	1.0	125



78 06 125

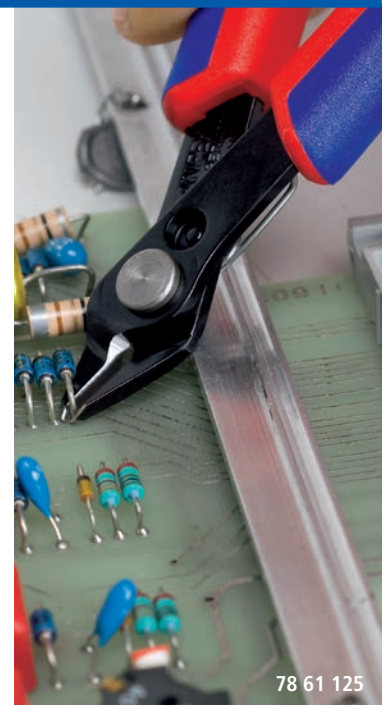

78 61 125

## Electronic Super Knips® XL

78

**Additional 15 mm longer version:  
greater stability, improved cutting performance**

- > Precision ground cutting edges without bevel for accurate flush cutting through the finest of wires e.g. in electronics and precision engineering
- > Precisely shaped tips also cut adjacent wires from Ø 0.2 mm
- > With opening spring and opening limiter for convenient, ergonomic and fast working due to automatic opening and user-friendly handle width
- > Extremely smooth movement for minimum operator fatigue due to joint with stainless steel rivet

### 78 03 140 / 78 03 140 ESD

- > Durable and stainless, made from INOX surgical steel, cutting edges hardened to 54 HRC

### 78 61 140 / 78 61 140 ESD

- > Heavy duty, made from burnished special tool steel, cutting edges additionally induction hardened to 64 HRC



Shear cut with controlled micro cutting edge misalignment for the most precise cutting of even the thinnest of wires and for a long service life



78 03 140



78 61 140 ESD

Article No.	EAN 4003773-		Handles	Capacity		↔ mm
				Ø mm	Ø mm	
78 03 140	081647	⚡ 🔴 🔴 🔴	with multi-component grips	0.2 - 2.1	1.2	140
78 03 140 ESD	081661	⚡ 🔴 🔴 🔴	with multi-component grips	0.2 - 2.1	1.2	140
78 61 140	081685	⚡ 🔴 🔴 🔴	with multi-component grips	0.2 - 2.1	1.4	140
78 61 140 ESD	081708	⚡ 🔴 🔴 🔴	with multi-component grips	0.2 - 2.1	1.4	140



# PLIERS ABC – TECHNICAL BASICS

## BASIC SHAPES OF THE JAWS

flat jaws

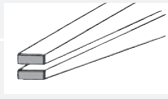

half-round jaws

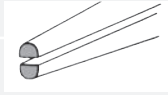

round jaws

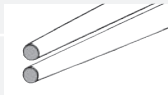

**Cutting Pliers**  
for cutting or nipping (diagonal, centre and end cutters, carpenters' pincers etc.)



**Gripping Pliers**  
(flat-, long-nose and water pump pliers etc.)

## JOINT CONNECTIONS

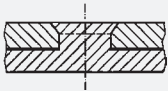

**Forged-in joint axle**

The rivet is part of one handle (forged from one piece)  
> high stability for highest strain  
> long service life

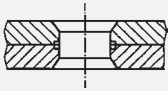

**Joint with inserted rivet**

A proved, sturdy and precise rivet connection for all standard pliers.

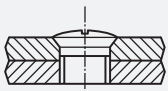

**Bolted joint**

For particularly demanding requirements in terms of precision and smooth operation, e.g. in circlip pliers and cable shears (even the finest multi-stranded conductors have to be cut cleanly).



**Combined Pliers**  
for cutting and gripping (combination, stork beak and radio pliers etc.)



**Special Pliers**  
for special applications, e.g. notching or punching different types of materials (sheet-metal nibbler, tile nibbling pincers etc.)

## TYPES OF JOINTS

**Lap joint**

The two plier halves lie on top of each other but are not milled out.

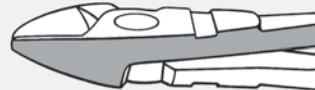

**Single joint**

Half the thickness in each pliers handle is milled away in the joint area so that both handles can be laid into each other.

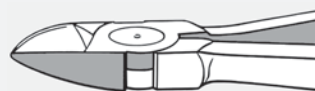

**Box joint**

One handle on the pliers is slit. The other handle is pushed through this slot. This joint connection can withstand a high level of load and strain because the joint bolt is supported on both sides and the inside handle is guided on both sides.

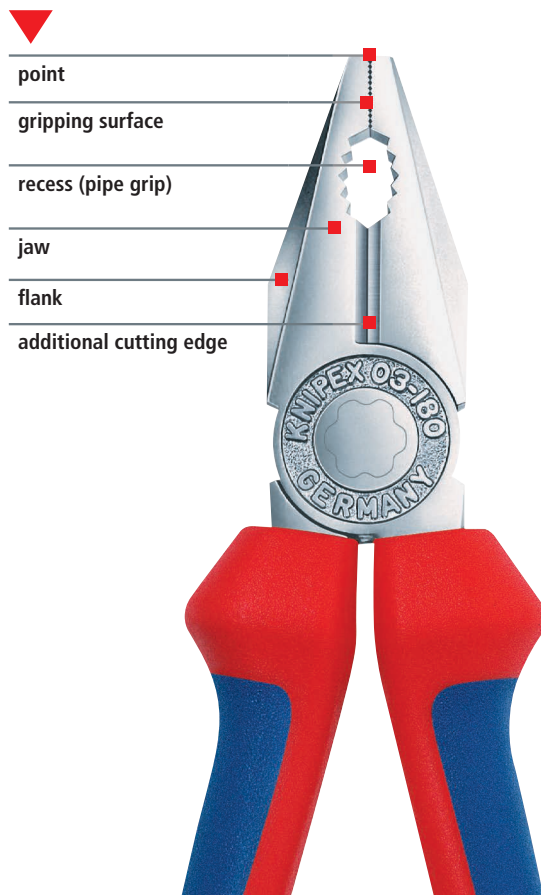
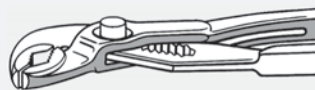

# CUTTING EDGE – TECHNICAL BASICS



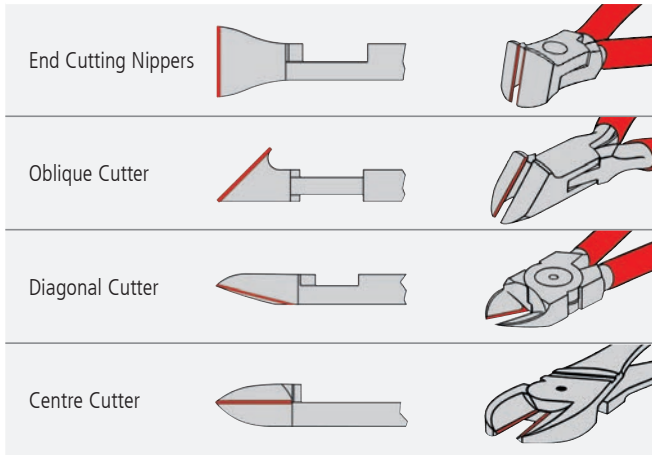

## Direction and position of cutting edges

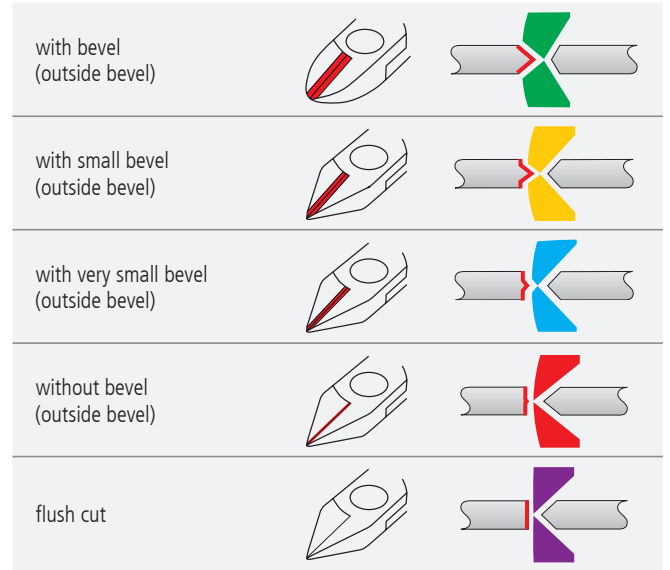

## Cutting edge shapes DIN ISO 5742



## WIRE CLASSES

	Material examples	Type of wire	Tensile strength	
			N/mm <sup>2</sup>	kp/mm <sup>2</sup>
	Copper, plastics	soft	220	22
	Nail, wire pin	medium-hard	750	75
	Wire rope strand, steel wire	hard	1800	180
	Spring steel wire	piano wire	2300	230

The maximum values indicated always stay for the performance cutting conditions, when the wire is placed as near as possible to the joint.

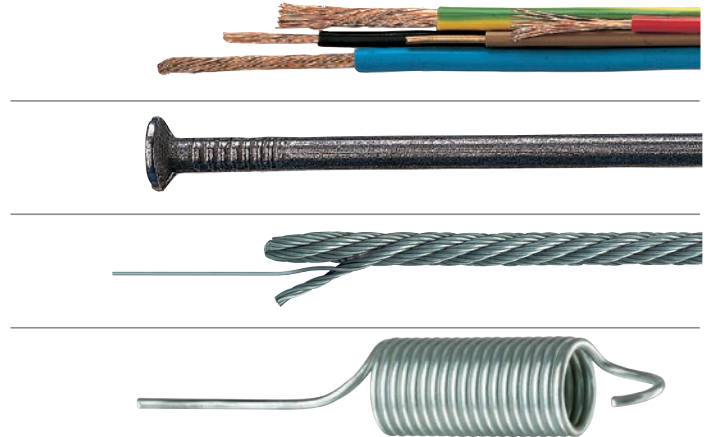

### Safety instructions

- > Each tool should only be used for its specified purpose.
- > When using cutting pliers: beware of wire ends flying off. Wear protective goggles and – if needed – gloves. Be aware of bystanders.
- > Only handles marked with the symbol  1000 V are insulated.



### Care Tips

A drop of oil on polished surfaces and in the joint will keep the tool in good working order and will increase the service life of your pliers.







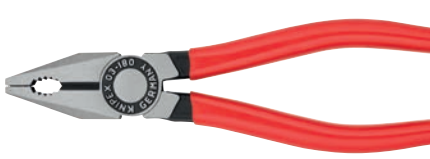

# STRUCTURE OF ARTICLE NUMBER

# HEAD/HANDLES

Basic model e. g. KNIPEX Cobra® Hightech Water Pump Pliers	Form e. g. straight	Finish e. g. head polished, handles with multi- component grips	Length e. g. 250 mm	Accessory e. g. Tethered Tools range
<b>87</b>	<b>0</b>	<b>2</b>	<b>250</b>	<b>T</b>

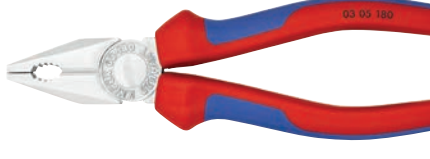
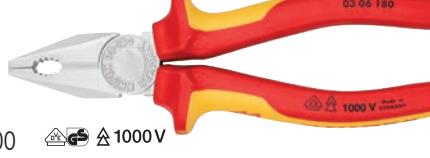

<b>0</b>	Pliers black atramentized, head polished	
<b>1</b>	Head polished, handles plastic coated	
<b>2</b>	Head polished, handles with multi-component grips	
<b>3</b>	Pliers chrome plated, handles plastic coated	
<b>4</b>	Pliers chrome plated	
<b>5</b>	Pliers chrome plated, handles with multi- component grips	
<b>6</b>	Pliers chrome plated, handles insulated with multi-component grips, VDE-tested	
<b>7</b>	Pliers chrome plated, handles with dipped insulation, VDE-tested	

# INDEX

## New products 2020

KNIPEX Cobra® XS .....	4	Long Nose Pliers .....	27
Pliers Wrench .....	6	Grip Pliers .....	28
KNIPEX StepCut .....	8	Welding Grip Pliers.....	28
KNIPEX CoBolt® S – with recess .....	9	Carpenters’ Pincers .....	29
KNIPEX PreciStrip 16.....	10	Farriers’ Pincers (Tear-off Pliers for vehicle bodywork).....	29
Oil Filter and Connector Pliers .....	11	Concreters’ Nippers.....	29
Automatic Insulation Stripper .....	11	Wire Rope Cutters forged .....	29
Pipe Cutter for plastic composite pipes .....	12	Wire Rope Cutters .....	30
Pipe Cutter for multilayer and pneumatic hoses.....	12	KNIPEX CoBolt® S .....	30
		KNIPEX CoBolt® .....	31
		KNIPEX CoBolt® XL .....	31
Hose Clamp Pliers .....	13	Pipe Cutter .....	32
Spring Hose Clamp Pliers.....	13	Anvil shears .....	32
KNIPEX Cobra® .....	14	Combination Shears .....	32
KNIPEX Cobra® QuickSet .....	14	Diagonal Cutters .....	33
KNIPEX Cobra® ES .....	15	KNIPEX X-Cut® .....	33
KNIPEX SmartGrip®.....	15	High Leverage Diagonal Cutters.....	34
Multiple Slip Joint Spanner .....	15	KNIPEX TwinForce® .....	34
KNIPEX Alligator® .....	16	KNIPEX StriX® .....	35
KNIPEX Alligator® XL.....	16	Insulation Strippers.....	35
KNIPEX Cobra® Set .....	16	Pliers for Electrical Installation .....	35
KNIPEX Alligator® Set.....	16	Automatic Insulation Stripper .....	36
Bestseller Set .....	16	KNIPEX MultiStrip 10 .....	36
Oil Filer and Connector Pliers .....	17	Crimping Pliers.....	37
KNIPEX TwinKey® .....	17	KNIPEX PreciForce® Crimping Pliers .....	37
Pliers Wrenches .....	18	KNIPEX MultiCrimp® Crimping Pliers with changer magazine .....	38
Pliers Wrench XL .....	18	Electronic Super Knips® .....	39
Set of pliers wrenches.....	18	Electronic Super Knips® XL .....	39
Precision Circlip Pliers.....	20		
Circlip Pliers .....	21		
Special Retaining Ring Pliers .....	22		
Precision Circlip Pliers Set.....	22		
Circlip Pliers Sets.....	22		
Pliers Sets .....	23		
Circlip Pliers Sets.....	23		
Ear Clamp Pliers.....	24		
Halogen Bulb Exchange Pliers.....	24		
Upholstery Pliers .....	24		
Long Reach Needle Nose Pliers.....	25		
Needle-Nose Combination Pliers.....	25		
Combination Pliers .....	26		
Mechanics’ Pliers.....	26		
Snipe Nose Side Cutting Pliers .....	27		

It is not permissible to copy the catalogue or parts of it in any way without our approval.

Subject to model modifications and technical changes. Illustrations, dimensions and weights are just approximate.

No liability is assumed for misprints or errors. Printed in the Federal Republic of Germany.

KNIPEX-Werk C. Gustav Putsch KG



## **KNIPEX-Werk**

**C. Gustav Putsch KG**

42337 Wuppertal  
Germany

Tel.: +49 202 47 94-0  
Fax: +49 202 47 74 94

[info@knipex.com](mailto:info@knipex.com)  
[www.knipex.com](http://www.knipex.com)

Follow us on:   



Your dealer